



INSTRUCTION MANUAL

HF TRANSCEIVER **IC-78**



IMPORTANT

READ THIS INSTRUCTION MANUAL CAREFULLY before attempting to operate the transceiver.

SAVE THIS INSTRUCTION MANUAL. This manual contains important safety and operating instructions for the IC-78.

EXPLICIT DEFINITIONS

WORD	DEFINITION
⚠ WARNING	Personal injury, fire hazard or electric shock may occur.
CAUTION	Equipment damage may occur.
NOTE	Inconvenience only. No risk of per of personal injury, fire or electric shock.

PRECAUTIONS

⚠ WARNING HIGH VOLTAGE! NEVER attach an antenna or internal antenna connector during transmission. This may result in an electric shock or burn.

⚠ NEVER apply AC to the [DC13.8V] jack on the transceiver rear panel. This could cause a fire or ruin the transceiver.

⚠ NEVER apply more than 16 V DC, such as a 24 V battery, to the [DC13.8V] jack on the transceiver rear panel. This could cause a fire or ruin the transceiver.

⚠ NEVER let metal, wire or other objects touch any internal part or connectors on the rear panel of the transceiver. This may result in an electric shock.

NEVER expose the transceiver to rain, snow or any liquids.

AVOID using or placing the transceiver in areas with temperatures below -10°C ($+14^{\circ}\text{F}$) or above $+60^{\circ}\text{C}$ ($+140^{\circ}\text{F}$). Be aware that temperatures on a vehicle's dashboard can exceed 80°C ($+176^{\circ}\text{F}$), resulting in permanent damage to the transceiver if left there for extended periods.

AVOID placing the transceiver in excessively dusty environments or in direct sunlight.

AVOID placing the transceiver against walls or putting anything on top of the transceiver. This will obstruct heat dissipation.

During mobile operation, **DO NOT** operate the transceiver without running the vehicle's engine. When the transceiver power is ON and your vehicle's engine is OFF, the vehicle's battery will soon become exhausted.

Make sure the transceiver power is OFF before starting the vehicle. This will avoid possible damage to the transceiver by ignition voltage spikes.

During maritime mobile operation, keep the transceiver and microphone as far away as possible from the magnetic navigation compass to prevent erroneous indications.

BE CAREFUL! The heatsink will become hot when operating the transceiver continuously for long periods.

BE CAREFUL! If a linear amplifier is connected, set the transceiver's RF output power to less than the linear amplifier's maximum input level, otherwise, the linear amplifier will be damaged.

Use Icom microphones only (supplied or optional). Other manufacturer's microphones have different pin assignments, and connection to the IC-78 may damage the transceiver.

IMPORTANT i
 EXPLICIT DEFINITIONS i
 PRECAUTIONS i

1 TABLE OF CONTENTS 1
 SUPPLIED ACCESSORIES 1

2 PANEL DESCRIPTION 2–7
 ■ Front panel 2
 ■ Function display 4
 ■ Rear panel 5
 ■ Microphone (HM-36) 7

3 INSTALLATION AND CONNECTIONS 8–12
 ■ Unpacking 8
 ■ Selecting a location 8
 ■ Grounding 8
 ■ Antenna connection 8
 ■ Required connections 9
 ■ Power supply connections 10
 ■ Advanced connections 11
 ■ External antenna tuners 12

4 OPERATION 13–27
 ■ Selecting a channel 13
 ■ Frequency indication 14
 ■ Lock function 14
 ■ Scan function 14
 ■ Basic voice receive and transmit 15
 ■ Mode selection 15
 ■ RF gain and Squelch 15
 ■ Functions for transmit 16
 ■ Functions for receive 19
 ■ Filter selection 21
 ■ Filter setting 22
 ■ Functions for CW 23
 ■ Functions for RTTY 25
 ■ Channel comment programming 27

5 SET MODE 28–33
 ■ General 28
 ■ Quick set mode items 29
 ■ Initial set mode items 31

6 EXTRA FEATURES 34–36
 ■ Instruction 34
 ■ VFO operation 34
 ■ 2-Tone alarm operation 36

7 INSTALLATION AND CONNECTIONS 37–38
 ■ Opening the transceiver’s case 37
 ■ Optional bracket and carrying handle 37
 ■ CR-338 HIGH STABILITY CRYSTAL UNIT 38
 ■ Optional IF filters 38

8 MAINTENANCE 39–40
 ■ Troubleshooting 39
 ■ Fuse replacement 40
 ■ Resetting the CPU 40

9 REMOTE JACK INFORMATION 41–42
 ■ CI-V remote control 41
 ■ Data cloning between transceivers 42

10 SPECIFICATIONS 43

12 OPTIONS 44–45

SUPPLIED ACCESSORIES

The transceiver comes with the following accessories.

	Qty.
① DC power cable 1	1
② Hand microphone (HM-36) 1	1
③ Fuse (FGB 20 A; for DC cable) 1	1
④ Fuse (FGB 4 A; internal use) 1	1

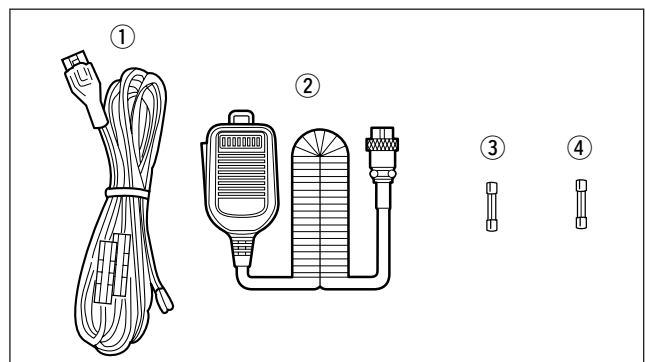

■ Front panel

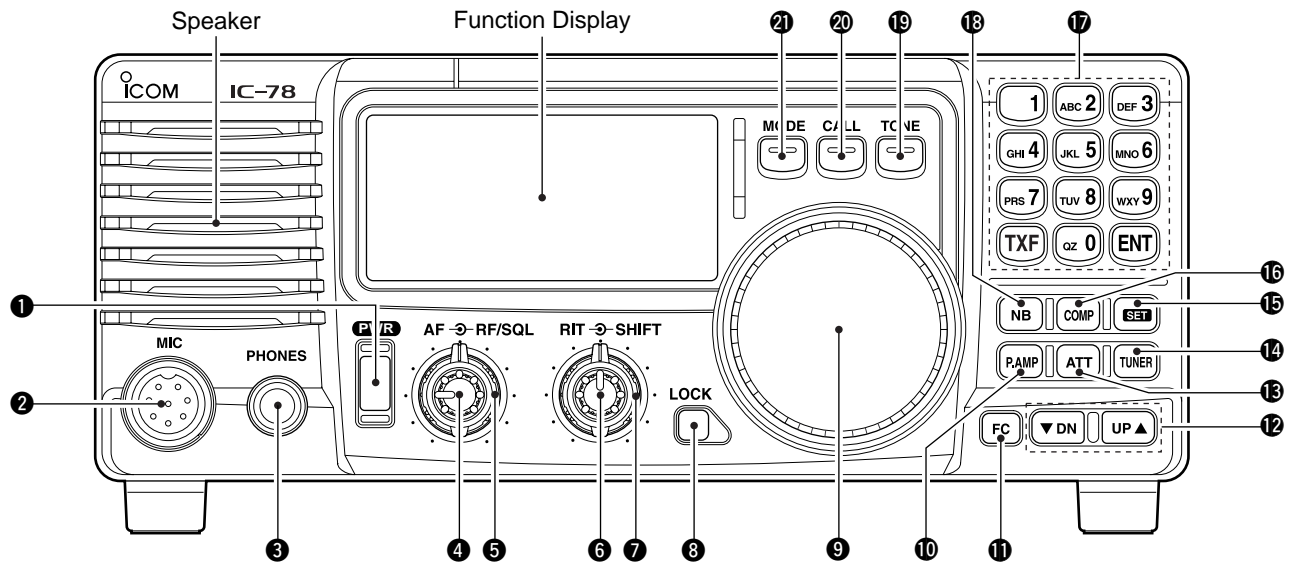

① POWER SWITCH [PWR]

- ➔ Push momentarily to turn power ON.
 - Turn the optional DC power supply ON in advance.
- ➔ Push for 1 sec. to turn power OFF.
- ➔ While pushing and holding [SET], push [PWR] to enter the *initial set mode*. (p. 28)

② MICROPHONE CONNECTOR [MIC]

- Accepts supplied or optional microphone.
- See p. 45 for appropriate microphones.
- See p. 7 for microphone connector information.

③ HEADPHONE JACK [PHONES] (p. 11)

- Accepts headphones.
- When headphones are connected, the internal speaker or connected external speaker does not function.

④ AF CONTROL [AF] (inner control)

- Varies the audio output level from the speaker.

⑤ RF GAIN/SQUELCH CONTROL [RF/SQL]

- (outer control; pgs. 15, 31)
- Adjusts the squelch threshold level. The squelch removes noise output from the speaker (closed condition) when no signal is received.
- The squelch is available for all modes.
- The control can be set as the squelch plus RF gain controls or squelch control only (RF gain is fixed at maximum) in initial set mode.

⑥ RIT CONTROL [RIT] (inner control; p. 19)

- ➔ Shifts the receive frequency ± 1.2 kHz for clear reception of an off frequency signal.
- Rotate the control clockwise to increase the frequency, or rotate the control counterclockwise to decrease the frequency. " RIT " appears on the display.

⑦ IF SHIFT CONTROLS [SHIFT]

- (outer control; p. 20)
- Shifts the center frequency of the receiver's IF passband.
- Rotate the control clockwise to shift the center frequency higher, or rotate the control counterclockwise to shift the center frequency lower.

⑧ LOCK SWITCH [LOCK] (p. 14)

- Push momentarily to turn the dial lock function ON and OFF.
- The dial lock function electronically locks the channel selector.

⑨ CHANNEL SELECTOR

- Selects an operating channel, sets conditions in the quick/initial set mode items, etc.

⑩ PREAMP SWITCH [P.AMP] (p. 19)

- Push to turn the preamp ON or OFF.

⑪ FC SWITCH [CH]

- ➔ Push to change the indication, channel comment or stored frequency. (p. 14)
- ⚡ **This key action only for some versions.**
- ➔ Push for 1 sec. to entering into VFO mode. (p. 35)

⑫ MEMORY CHANNEL UP/DOWN SWITCHES [▼ DN]/[UP ▲]

- ➔ Push to select the operating channel. (p. 13)
- ➔ Push for 1 sec. to start scanning. (p. 14)
- ➔ Push to select the *quick/initial set mode* items while *quick/initial set mode* is selected. (p. 28)
- ➔ Push to select the digit of channel comment while editing. (p. 27)

13 ATTENUATOR SWITCH [ATT] (p. 19)

Push to turn the 20 dB attenuator function ON and OFF.

14 TUNER SWITCH [TUNER] (p. 18)

- ➔ Push to turn the antenna tuner function ON and OFF.
- ➔ Push for 1 sec. to manually tune the tuner.
 - An optional antenna tuner must be connected.
 - When the tuner cannot tune the antenna, the tuning circuit is bypassed automatically after 20 sec.

15 SET SWITCH [SET]

- ➔ Push for 1 sec. to enter the *quick set mode*. (p. 28)
- ➔ Push and hold [SET], then push [PWR] to enter the *initial set mode*. (p. 28)
- ➔ Push to change the meter function; (p. 16)
 - PO: indicates the relative RF output power.
 - ALC: Indicates ALC level.
 - SWR: Indicates the SWR over the transmission line.

16 MIC COMPRESSOR SWITCH [COMP] (p. 17)

Turn the Mic. compressor function ON and OFF.

17 KEYPAD

The keypad can be used for several functions as described below:

- ➔ [0] to [9]
 - For entering operating channel number. (p. 13)
 - Selects a character during channel comment programming. (p. 27)
- ➔ [ENT]
 - Direct channel number input. (p. 13)
- ➔ [TXF]
 - Transmit frequency indication. (p.14)
 - Selects a space and changes the editing digit during channel comment programming. (p. 27)

18 NOISE BLANKER SWITCH [NB] (p. 19)

- ➔ Turns the noise blanker ON and OFF. The noise blanker reduces pulse-type noise such as that generated by automobile ignition systems. This function is not effective against non pulse-type noise.
- ➔ Push [NB] for 1 sec. to enter the noise blanker level setting condition.

19 TONE SWITCH [TONE]

- ☞ **This key action may differ according to version.**
- ➔ Selects the call channel and emits a distress alarm tone from the speaker. (p. 36)
- ➔ Transmits a distress alarm or alarm testing signal when pushed for 1 sec. (p. 36)
 - Cancel the distress alarm tone emission, or distress alarm transmission.
- ➔ Selects the tuning step item in the *quick set mode* directly.
- ➔ No function is assigned.

20 CALL SWITCH [CALL]

- ➔ Push to select call channel.
 - Push again to return to previous condition.

21 MODE SWITCH [MODE] (p. 15)

- ➔ Push to change an operating mode.
 - Push [MODE] for 1 sec. during SSB mode to switch between LSB or USB.
 - Push [MODE] for 1 sec. during CW or RTTY mode, to switch between CW and CW reverse or RTTY and RTTY reverse. “**REV**” appears on the display.

■ Function display

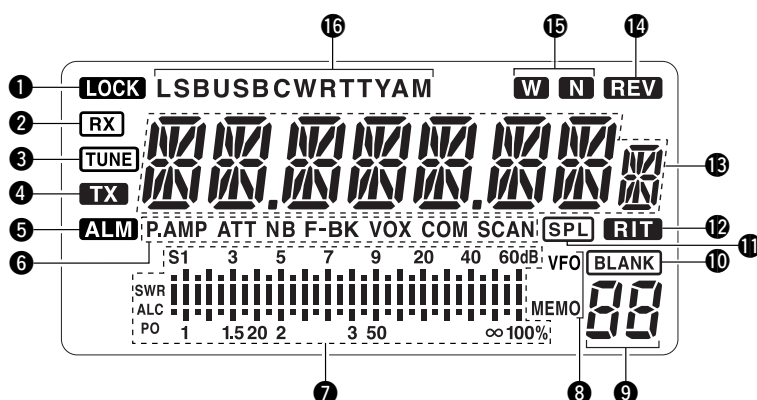

- 1 LOCK INDICATOR** (p. 14)
Appears when the dial lock function is in use.
- 2 RECEIVE INDICATOR**
Appears while receiving a signal or when the squelch is open.
- 3 TUNE INDICATOR**
 - ➔ Appears or disappears when the connected automatic tuner is tuned completely, depending on connected antenna tuner type.
 - ➔ Flashes while tuning.
- 4 TRANSMIT INDICATOR**
 - ➔ Appears while transmitting.
 - ➔ Flashes while transmit frequency is indicated.
- 5 ALARM INDICATOR**
 - ☞ **This indicator appears only some versions.**

Appears while 2-tone alarm is emitting or transmitting
- 6 FUNCTION INDICATORS**
 - ➔ “P.AMP” appears when preamp is activated.
 - ➔ “ATT” appears when the RF attenuator is activated.
 - ➔ “NB” appears when the Noise Blanker is activated.
 - ➔ “BK” appears when the semi break-in function is selected in *quick set mode*.
 - ➔ “F-BK” appears when the full break-in function activates in CW mode. (p. 23)
 - ➔ “VOX” appears when the VOX function is selected in *quick set mode*.
 - ➔ “COM” appears when the speech compressor activates in SSB mode.
 - ➔ “SCAN” appears during scanning.
 - Flashes when scan is paused.
- 7 SIGNAL/SQL/RF-GAIN METER**
 - ➔ Functions as an S-meter while receiving.
 - ➔ Functions as a Power, ALC or SWR meter while transmitting. (p. 16)
- 8 VFO/MEMORY INDICATOR**
 - ➔ “MEMO” appears during regular operation.
 - ☞ **This indicator appears only some versions.**
 - ➔ “VFO” appears during VFO operation.
- 9 CHANNEL NUMBER READOUT** (p. 13)
Shows the selected channel number.
- 10 BLANK INDICATOR**
Appears when no frequency programmed channel is selected.
- 11 SPLIT INDICATORS** (p. 13)
Appears when the duplex channel, in which different frequencies between transmit and receive are programmed, is selected.
- 12 RIT INDICATOR** (p. 19)
Appears when the RIT function is in use.
- 13 CHANNEL READOUT**
Shows the memory names, or stored frequency of the selected channel.
- 14 REVERSE INDICATOR** (p. 15)
Appears when the CW reverse or RTTY reverse mode is selected.
- 15 WIDE/NARROW FILTER INDICATORS** (pgs. 21, 22)
 - ➔ “W” appears when the wide IF filter is selected.
 - ➔ “N” appears when the narrow IF filter is selected.
- 16 MODE INDICATORS** (p. 15)
Indicates the temporarily selected operating mode.

■ Rear panel

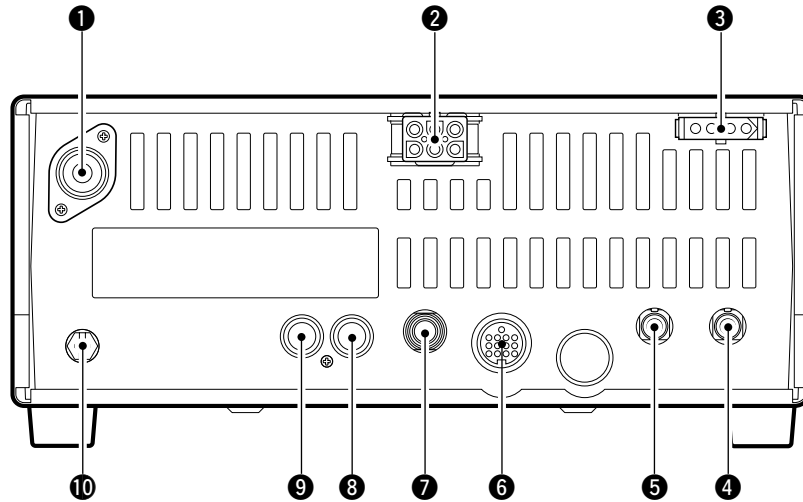

- 1 ANTENNA TERMINAL [ANT]** (p. 9)
Connects a 50 Ω antenna with a PL-259 connector and a 50 Ω coaxial cable.
- 2 DC POWER SOCKET [DC 13.8V]** (p. 10)
Accepts 13.8 V DC through the supplied DC power cable.

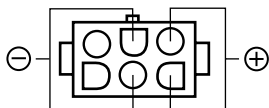

Rear panel view

- 3 TUNER CONTROL SOCKET [TUNER]** (p. 11)
Accepts the control cable from an optional antenna tuner.
- 4 REMOTE JACK [REMOTE]** (p. 11)
For use with a personal computer for remote operation of transceiver functions, and data cloning between transceivers.
- 5 EXTERNAL SPEAKER JACK [EXT SP]**
Connects an 8 Ω external speaker, if desired.
 - When an external speaker is connected, the internal speaker does not function.
- 6 ACCESSORY SOCKET [ACC]** (p. 6)
Enables connection to external equipment such as a TNC for data communications or a linear amplifier, etc.

- 7 ELECTRONIC KEYS JACK [KEY]**
Accepts a paddle to activate the internal electronic keyer.
 - Selection between the internal electronic keyer and straight key operation can be made in initial set mode.

When connecting a straight key

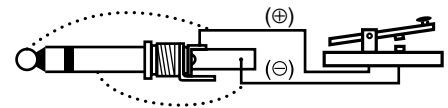

When connecting a paddle

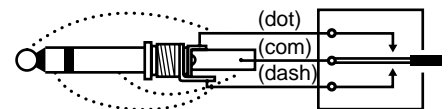

- 8 ALC INPUT JACK [ALC]**
Connects to the ALC output jack of a non-Icom linear amplifier.
- 9 SEND CONTROL JACK [SEND]**
Goes to ground while transmitting to control external equipment such as a linear amplifier.
 - Max. control level: 16 V DC/2 A
- 10 GROUND TERMINAL [GND]** (p. 9)
Connects the terminal to ground.

2 PANEL DESCRIPTION

◇ ACC SOCKET INFORMATION

• ACC socket

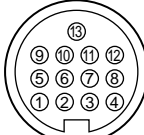
ACC	PIN #	NAME	DESCRIPTION	SPECIFICATIONS
 <p>Rear panel view</p>	1	8 V	Regulated 8 V output.	Output voltage : 8 V \pm 0.3 V Output current : Less than 10 mA
	2	GND	Connects to ground.	—
	3	SEND	Input/output pin. Goes to ground when transmitting. When grounded, transmits.	Ground level : -0.5 V to 0.8 V Input current : Less than 20 mA
	4	BDT	Data line.	—
	5	BAND	Band voltage output.	
	6	ALC	ALC voltage output.	Control voltage : -4 V to 0 V Input impedance : More than 10 k Ω
	7	NC	—	— —
	8	13.8 V	13.8 V output when power is ON.	Output current : Max. 1 A
	9	TKEY	Key line.	—
	10	FSKK	RTTY key input.	Ground level : -0.5 V to 0.8 V Input current : Less than 10 mA
	11	MOD	Modulation input.	Input impedance: 10 k Ω Input level : Approx. 100 mV rms
	12	AF	AF detector output. Fixed, regardless of [AF] position.	Output impedance: 4.7 k Ω Output level : 100–300 mV rms
	13	SQLS	Squelch output. Goes to ground when squelch opens.	SQL open : Less than 0.3 V/5 mA SQL closed : More than 6.0 V/100 μ A

•When connecting the ACC conversion cable (OPC-599)

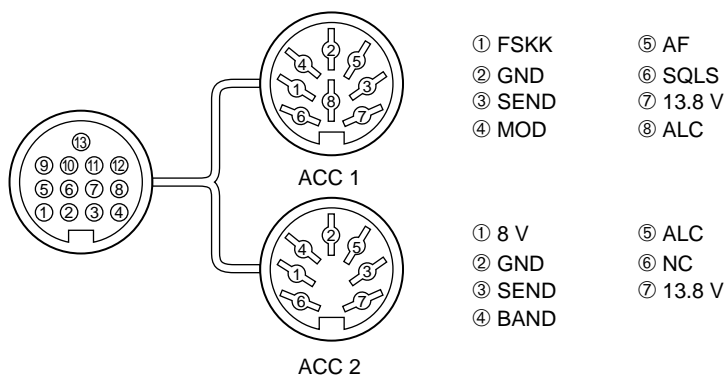

Microphone (HM-36)

DESCRIPTION

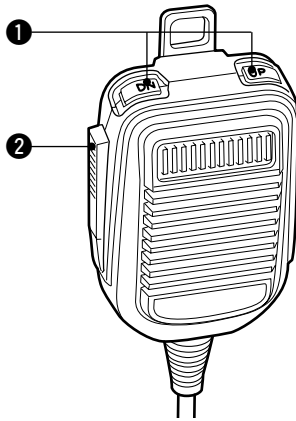

1 UP/DOWN SWITCHES [UP]/[DN]

Change the selected readout frequency or memory channel.

- Continuous pushing changes the frequency or memory channel number continuously.
- The [UP]/[DN] switch can simulate a key paddle. Preset in the CW PADDL in initial set mode. (p. 32)

2 PTT SWITCH

Push and hold to transmit; release to receive.

HM-36 SCHEMATIC DIAGRAM

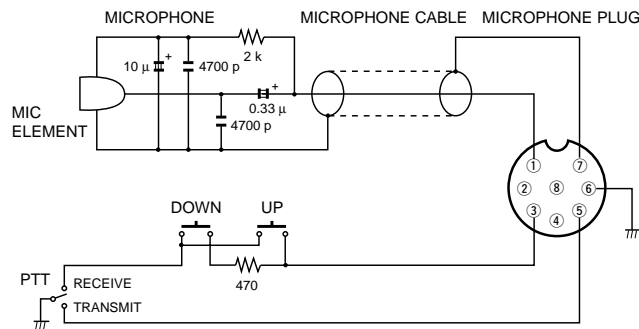

MICROPHONE CONNECTOR

(Front view)

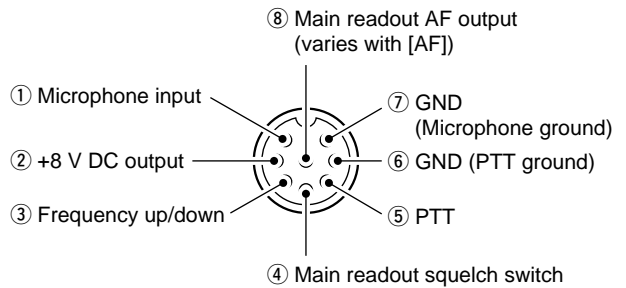

[MIC] Pin No.	FUNCTION	DESCRIPTION
2	+8 V DC output	Max. 10 mA
3	Frequency up	Ground
	Frequency down	Ground through 470 Ω
4	Squelch open	"Low" level
	Squelch closed	"High" level

CAUTION: DO NOT short pin 2 to ground as this can damage the internal 8 V regulator.

■ Unpacking

After unpacking, immediately report any damage to the delivering carrier or dealer. Keep the shipping cartons.

For a description and a diagram of accessory equipment included with the IC-78, see 'Supplied accessories' on p. 1 of this manual.

■ Selecting a location

Select a location for the transceiver that allows adequate air circulation, free from extreme heat, cold, or vibrations, and away from TV sets, TV antenna elements, radios and other electro-magnetic sources.

The base of the transceiver has an adjustable stand for desktop use. Set the stand to one of two angles depending on your operating conditions.

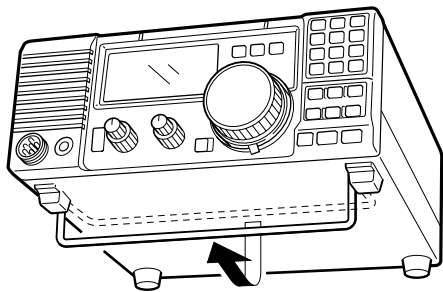

■ Grounding

To prevent electrical shock, television interference (TVI), broadcast interference (BCI) and other problems, ground the transceiver through the GROUND terminal on the rear panel.

For best results, connect a heavy gauge wire or strap to a long earth-sunk copper rod. Make the distance between the [GND] terminal and ground as short as possible.

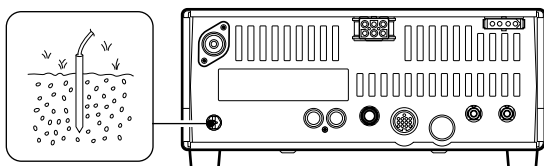

⚠ WARNING: NEVER connect the [GND] terminal to a gas or electric pipe, since the connection could cause an explosion or electric shock.

■ Antenna connection

For radio communications, the antenna is of critical importance, along with output power and sensitivity. Select antenna(s), such as a well-matched 50 Ω antenna, and feed line. 1.5:1 or better of Voltage Standing Wave Ratio (VSWR) is recommended for your desired band. Of course, the transmission line should be a coaxial cable.

⚠ CAUTION: Protect your transceiver from lightning by using a lightning arrester.

PL-259 CONNECTOR INSTALLATION EXAMPLE

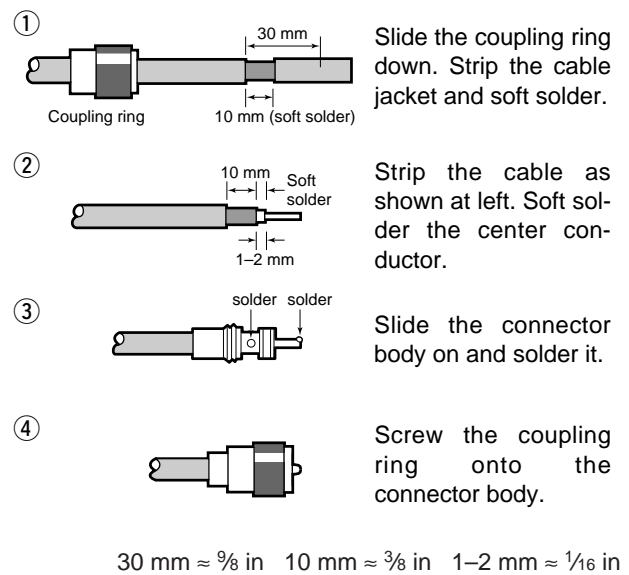

Antenna SWR

Each antenna is tuned for a specified frequency range and SWR may be increased out-of-range. When the SWR is higher than approx. 2.0:1, the transceiver's power drops to protect the final transistor. In this case, an antenna tuner is useful to match the transceiver and antenna. Low SWR allows full power for transmitting even when using the antenna tuner. The IC-78 has an SWR meter to monitor the antenna SWR continuously.

Required connections

•Front panel

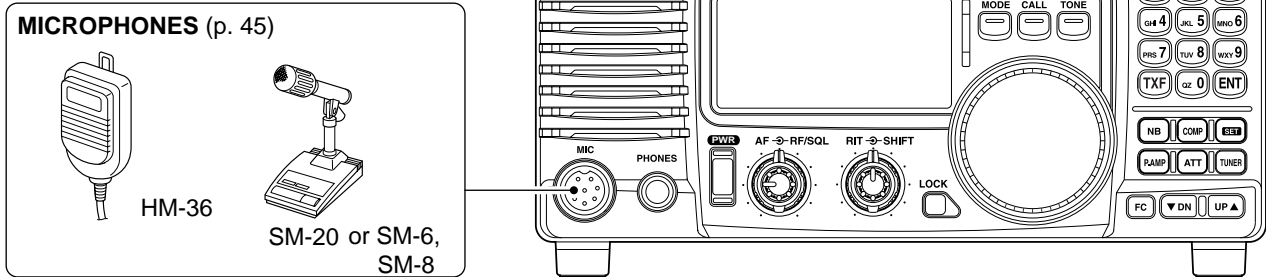

•Rear panel

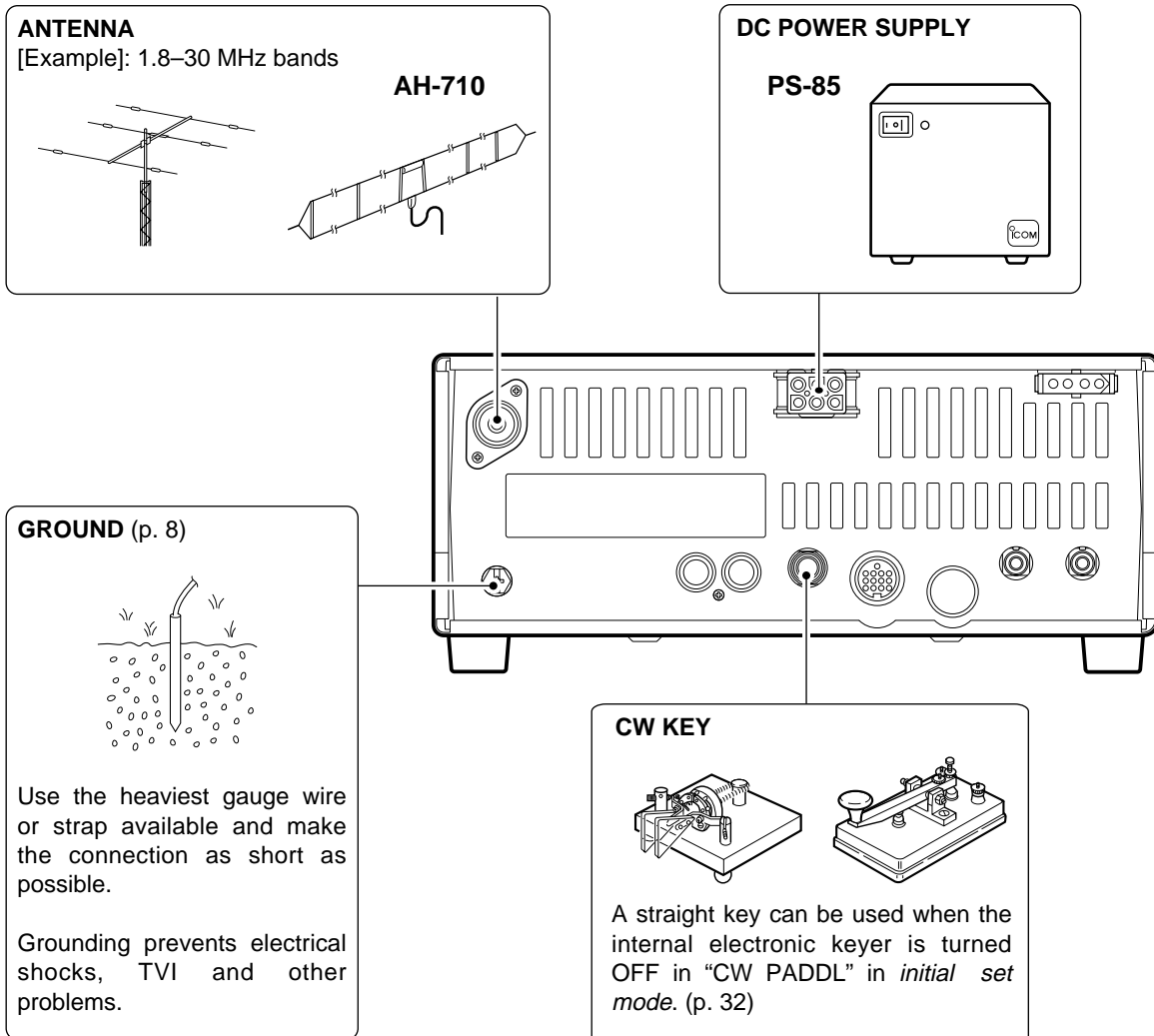

3 INSTALLATION AND CONNECTIONS

■ Power supply connections

Use an optional PS-85 DC POWER SUPPLY when operating the IC-78 with AC power. Refer to the diagrams below.

CAUTION: Before connecting the DC power cable, check the following important items. Make sure:

- The [PWR] switch is OFF.
- Output voltage of the power source is 12–15 V when you use a non-Icom power supply.
- DC power cable polarity is correct.
 - Red : positive ⊕ terminal
 - Black : negative ⊖ terminal

CONNECTING PS-85 DC POWER SUPPLY

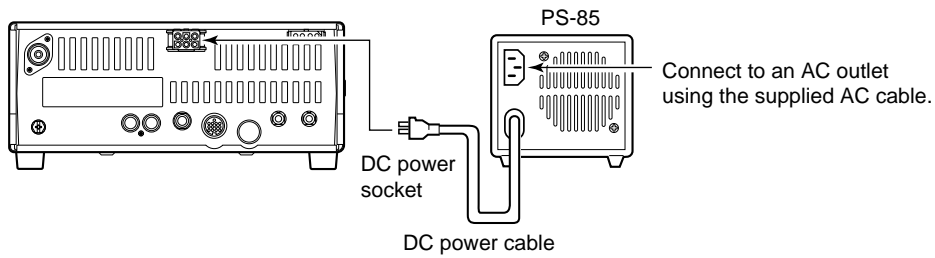

CONNECTING NON-ICOM DC POWER SUPPLY

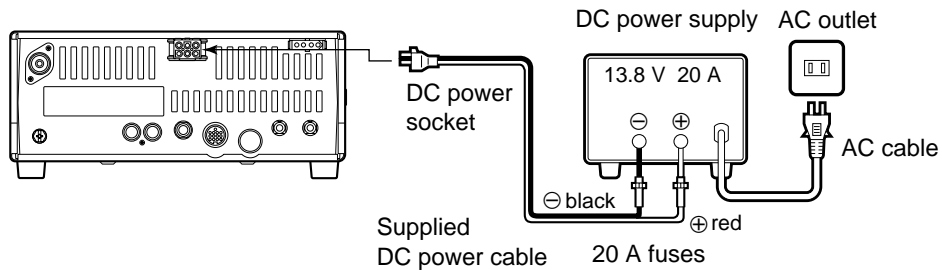

CONNECTING A VEHICLE BATTERY

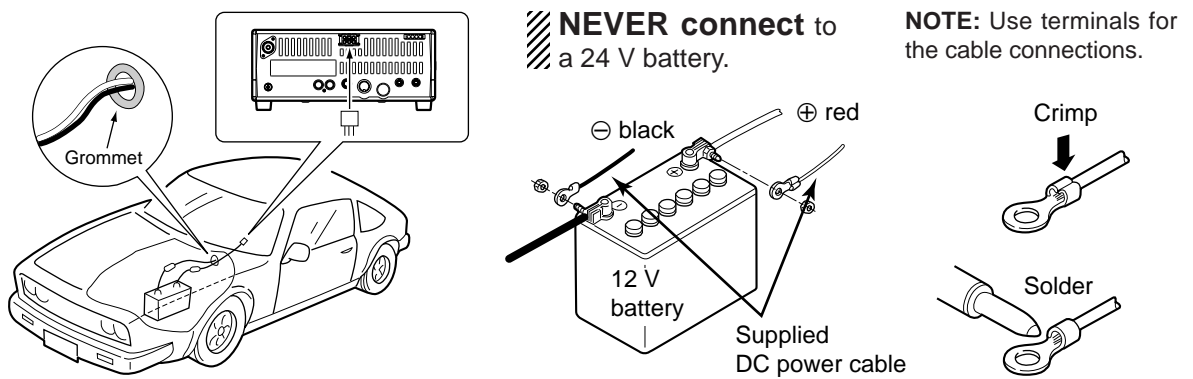

Advanced connections

•Front panel

MIC
The AFSK modulation signal can be input from [MIC]. (p. 25)

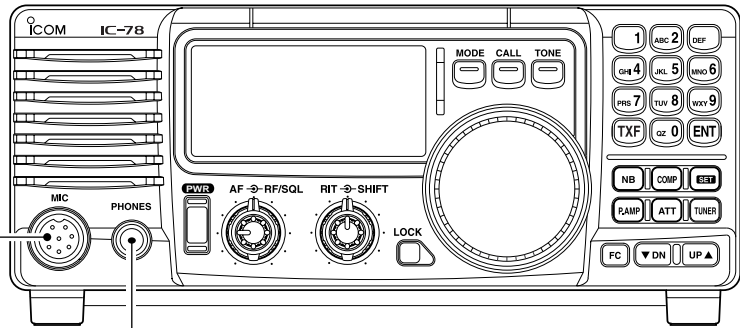

HEADPHONES



•Rear panel

AT-120,
AT-130, or
AH-4 (p. 44)

with

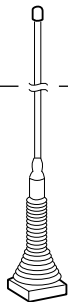
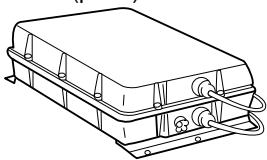

AH-2b
or long wire

[REMOTE] (pgs. 41, 42)

Used for computer control and transceive operation, and cloning operation between transceivers.

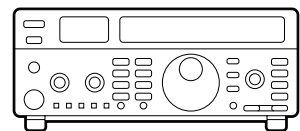

ANTENNA

Connects a linear amplifier, etc.

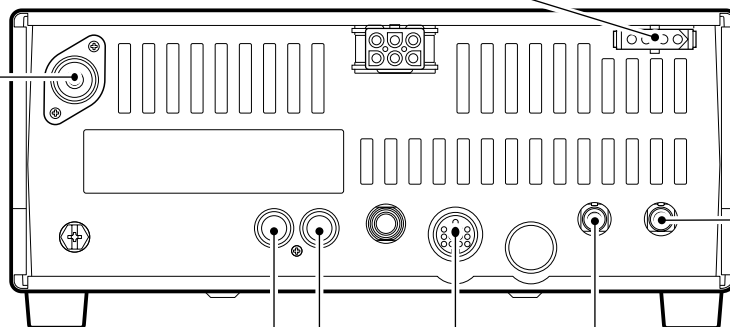

ACC SOCKETS (p. 6)

[SEND], [ALC]

Used for connecting a non-Icom linear amplifier.

EXTERNAL SPEAKER (p. 44)

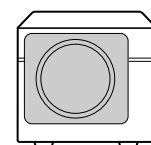

SP-21, etc.

External antenna tuners

CONNECTING AN ANTENNA TUNER (p. 44)

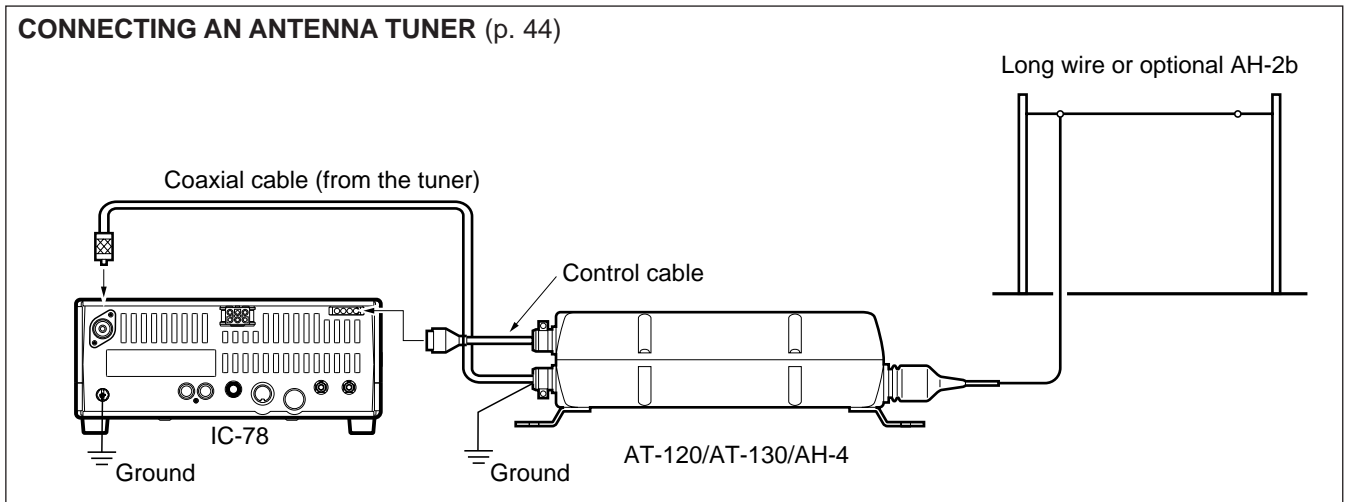

■ Selecting a channel

The transceiver has 99 memory channels. However, the number of channels can be restricted in *initial set mode* (p. 32) depending on your needs. A total of 3 ways of channel selections are available to suit your operating style.

◇ Using the channel selector

Rotate the channel selector clockwise (channel number increases) or counterclockwise (channel number decreases) to select desired channel.

This is the most useful way of channel selection.

◇ Using up/down switches

Push [▼ DN]/[UP ▲] on the front panel or the microphone to select the desired channel.

This way is convenient when changing a small number of channels.

- When a duplex channel (different frequencies between transmit and receive) is selected, “**SPL**” appears.

◇ Using the keypad

Enter the number of the desired channel number using the keypad (0 to 9), then push [ENT].

This way is convenient for remembering the usage and stored channel number, or when changing large a number of channels.

- When a duplex channel (different frequencies between transmit and receive) is selected, “**SPL**” appears.
- When a blank channel (no frequency is programmed) is selected, “**BLANK**” appears.

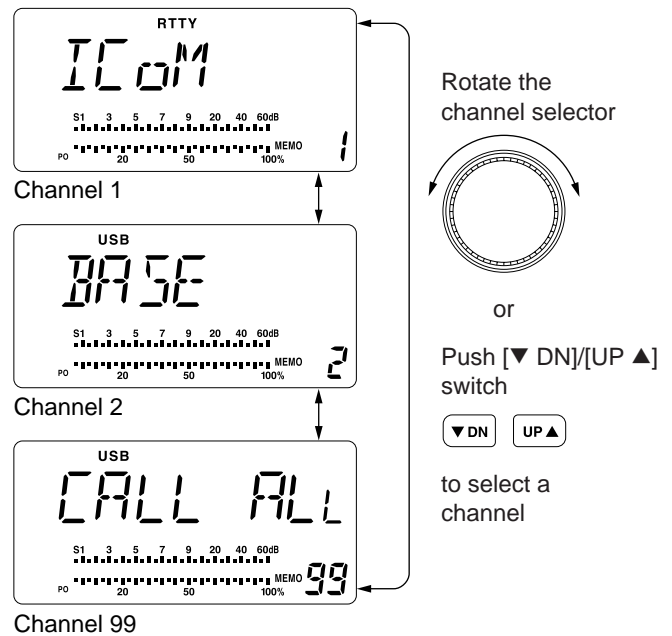

• Example 1— selecting channel 8

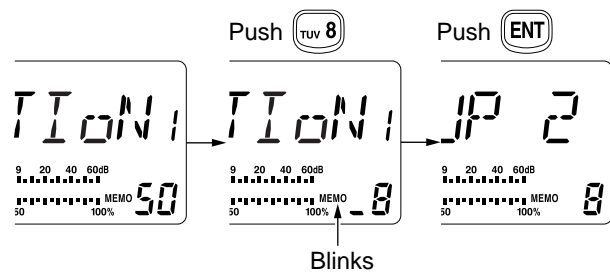

• Example 2— selecting channel 25

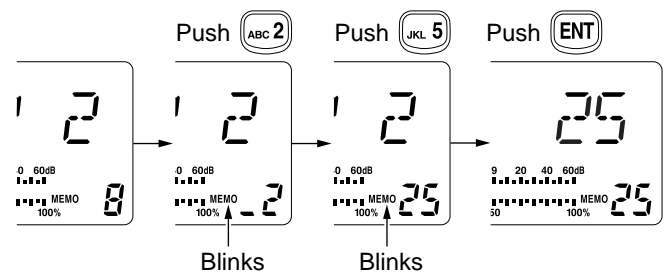

Frequency indication

By pushing the [FC], channel comment indication or frequency indication can be selected.

◇ Transmit frequency indication

By pushing the [TXF], transmit frequency is indicated, regardless channel comment or frequency indication.

While transmit frequency is indicated, “TX” flashes.

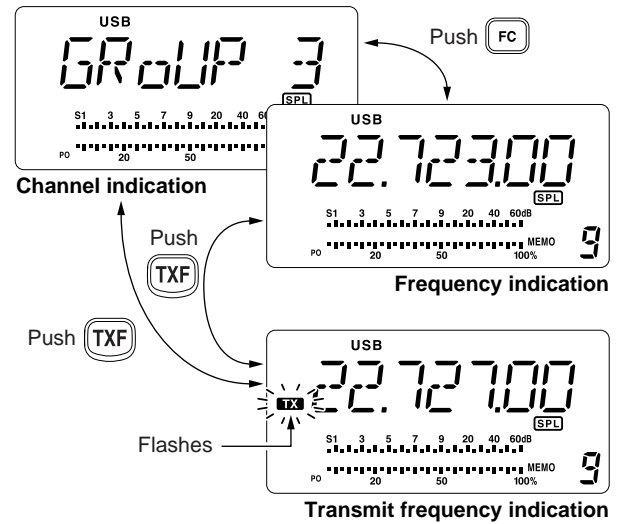

Lock function

The lock function electronically locks the main dial to prevent accidental channel changing.

Push [LOCK] to turn the lock function ON and OFF. Before channel selection, turn this function OFF.

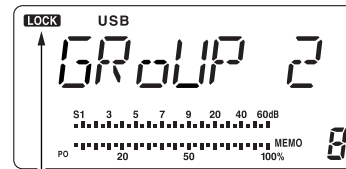

Appears while lock function is activated.

Scan function

Scan function repeatedly scans programmed channels. This function is convenient to wait for calls on multiple channels.

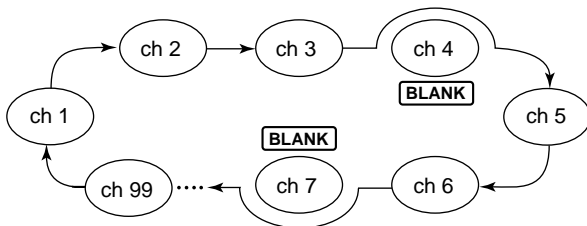

① Set [RF/SQL] control at the center (12 o'clock) position (opening squelch), then rotate [RF/SQL] control clockwise to the position where the noise disappears.

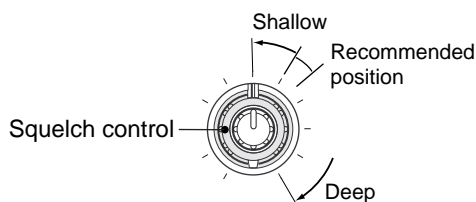

② Push [▼ DN] or [UP ▲] for 1 sec. to start channel scan.

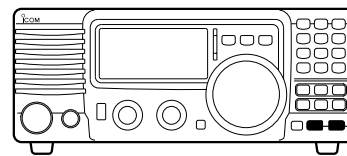

[▼ DN]/[UP ▲] switches

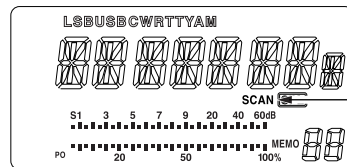

Appears while scanning.

• The “SCAN” indicator appears.

③ When a signal is received, channel scan pauses on that channel.

④ Push [▼ DN] or [UP ▲] to cancel channel scan.

NOTE: The scan resume condition (the action after signal receiving) can be selected as “scan resume” or “scan cancel” in the *initial set mode* (p. 31).

Basic voice receive and transmit

- ① Check the following in advance:
 - ➔ Microphone is connected.
 - ➔ [AF] control is set to minimum position.
 - ➔ [RF/SQL] is set to center position (squelch open).
 - ➔ [RIT] control set to center position.

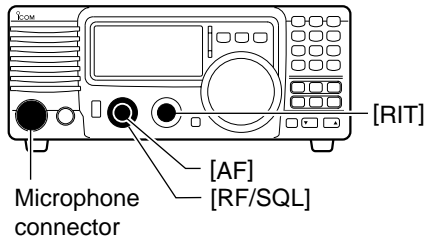

- ② Selects the desired channel to be received with the channel selector, [▼ DN]/[UP ▲], or 10-key pad.
 - The S-meter shows signal strength when signal is received.

- ③ Adjust [AF] to the desired audio level when receiving a signal.
- ④ Push [MODE] to select the desired operation mode, if the received signal is in a different mode.
- ⑤ If the bass or treble of the receive audio is too strong, rotate [RIT] control to obtain clear audio. (p. 19)
- ⑥ Push [TUNER] to tune the antenna tuner, if connected.
 - "TUNE" indicator flashes for 1 to 2 sec. for the first tuning on a channel.
- ⑦ Push and hold [PTT] on the microphone, and speak into the microphone at a normal voice level.
 - The RF meter shows the output power according to your voice level, when RF power meter is selected.
- ⑧ Release [PTT] to return to receive.

Mode selection

The following modes are available in the IC-78: SSB (LSB/USB), CW, CW REV (CW reverse), RTTY, RTTY REV (RTTY reverse) and AM.

- ➔ Push [MODE] to select desired operation mode.
- ➔ Push [MODE] for 1 sec. to change between USB and LSB, CW and CW reverse or RTTY and RTTY reverse. (SSB, CW and RTTY mode only)
- The selected mode is indicated in the function display.

Note: The selected mode can be used for temporary operation only.

OPERATING MODE SELECTION

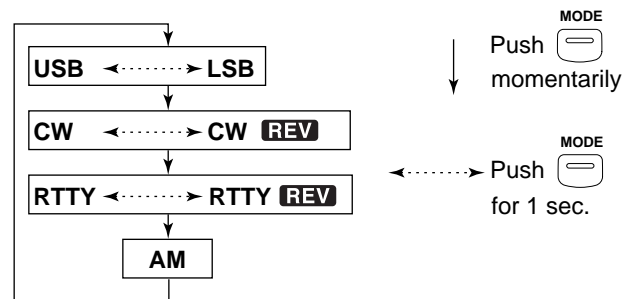

RF gain and Squelch

The [RF/SQL] control adjusts either the RF gain or the squelch. The action depends on the operating mode and the condition of the RF/SQL item in *initial set mode* (p. 31).

• [RF/SQL] control priority

Set mode setting	SSB, CW, RTTY	AM
rS (RF/SQL)	RF/SQL	RF/SQL
At (Auto)	RF gain	SQL*
Sq (SQL) (default)	SQL*	SQL*

* The RF gain is set to maximum level when the [RF/SQL] is set as [SQL] control.

The *RF gain* is used to adjust the receiver gain.

- Shallow rotation moves the S-meter to the right indicating the signal strength which can be received.

▨ The recommended position for RF gain is the 12 o'clock position since this sets RF gain to the max.

The *SQUELCH* removes noise output from the speaker (closed condition) when no signal is received. The squelch is available for the other modes.

- A segment appears in the S-meter to indicate the S-meter squelch level.

• When set as the [RF/SQL] control

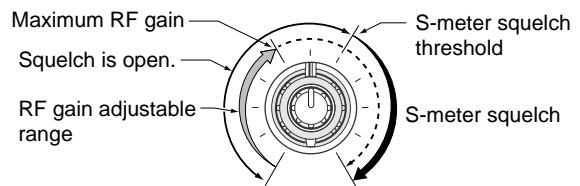

• When set as the [SQL] control

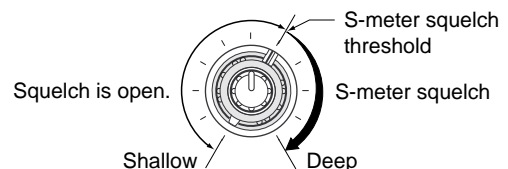

• When set as the [RF] control

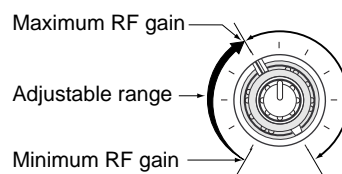

■ Functions for transmit

◇ Output power and microphone gain

•Setting output power

- ① Push [SET] for 1 sec. to select *quick set mode*.
- ② Push [▲UP]/[▼DN] to select "RF POWER".
- ③ Rotate the main dial to select the desired output.
 - Output power is displayed in 101 steps (L, 1–99 and H) but is continuously selectable.

•Available power

SSB/CW/RTTY: 2 (or less) to 100 W

AM: 2 (or less) to 40 W*

*Carrier power

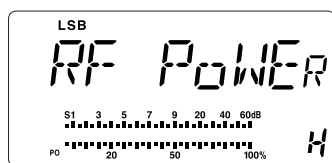

Maximum output power is selected.

•Setting microphone gain

Microphone gain must be adjusted properly so that your signal does not distort when transmitted.

- ① Select SSB or AM mode.
- ② Push [SET] for 1 sec. to enter the quick set mode.
- ③ Push [▲UP]/[▼DN] to select "MIC GAIN".
- ④ Adjust the mic gain while speaking into the microphone, so that the ALC meter does not exceed the ALC zone.
- ⑤ Push [SET] to exit *quick set mode*.

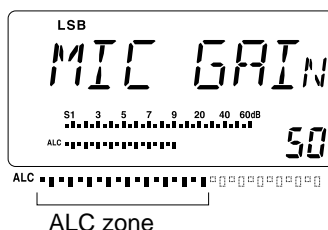

Microphone gain is set to 50.

◇ Meter function

The bar meter in the function display acts as an S-meter (for relative signal strength) during receive and can be selected for one of three functions during transmit.

- Push [SET] to select the PO, ALC and SWR meter mode.

• Measuring SWR

- ① Confirm that the output power is over 30 W.
- ② Push [SET] to select the SWR meter.
- ③ Push [MODE] to select CW or RTTY operation.
 - Key down or push [PTT] to transmit; then read the actual SWR from the meter:
 - ≤1.5; well matched antenna
 - ≥1.5; check antenna or cable connection, etc.

Display Indication	Measurement
PO	Indicates the relative RF output power.
ALC	Indicates the ALC level. When the meter movement shows the input signal level exceeds the allowable level, the ALC limits the RF power. In such cases, reduce the microphone gain (see above).
SWR	Indicates the SWR over the transmission line.

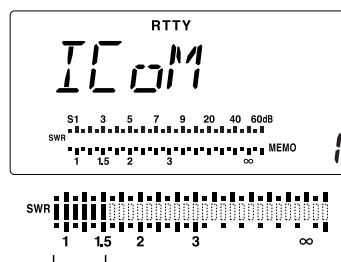

The best match is in this range.

◇ Microphone compressor

IC-78 has a built-in, low distortion Mic compressor circuit. This circuit increases your average talk power in SSB mode and is especially useful when the receiving station is having difficulty copying your signal.

- ① Select USB or LSB mode.
- ② Push [COMP] switch to turn mic compressor ON.

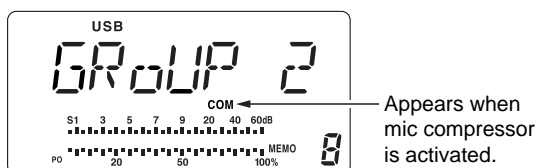
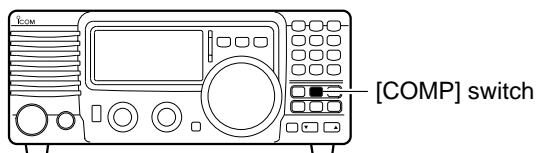

Appears when mic compressor is activated.

- “COM” indicator appears.

- ③ Confirm the ALC level.
 - Push [SET] to select the ALC meter.
 - Speak into the microphone at a normal voice level.
 - If the ALC meter peak past the ALC zone, re-adjust the mic. gain. (p.16)
 - Be sure the mic gain is in the range of 20 to 50.

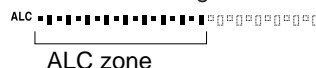

Adjust [MIC GAIN] so that the ALC meter reads within the ALC zone.

Note: When the ALC meter peaks above the ALC zone, your transmitted voice may be distorted.

◇ VOX operation

The VOX (Voice-operated Transmission) function switches between transmit and receive with your voice. This function provides an opportunity to input log entries into your computer, etc. while operating.

- ① Select “VOX” in *quick set mode*.
 - Push [SET] for 1 sec. to select *quick set mode*.
 - Push [▲UP]/[▼DN] to select “VOX”.
- ② Rotate the channel selector to turn VOX function ON.

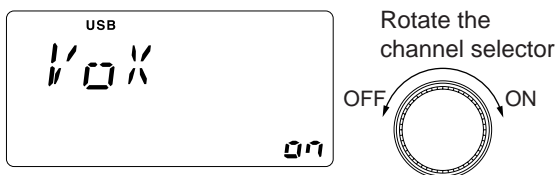

- ③ Select “VOX GAIN” in *quick set mode*.
 - Push [▲UP]/[▼DN] to select “VOX”.
- ④ While speaking into the microphone, adjust [VOX GAIN] with the channel selector, until the transceiver is transmitting.
- ⑤ Select “VOX DELY” in *quick set mode*.
 - Push [▲UP]/[▼DN] to select “VOX Delay”
- ⑤ While speaking into the microphone, adjust [VOX DELY] as desired.
- ⑥ Select “ANTI-VOX” in *quick set mode*.
 - Push [▲UP]/[▼DN] one or more times to select “ANTI-VOX”
- ⑦ If the receive audio from the speaker switches the transceiver to transmit during receive, adjust the “ANTI-VOX” to the point where it has no effect.
- ⑧ Push [SET] to exit *quick set mode*.

◇ Optional AT-120/AT-130/AH-4 operation

The AT-120, AT-130 or AH-4 matches the IC-78 to a long wire antenna more than 7 m (23 ft) long (3.5 MHz and above).

- See p. 11 for connection.
- See the connected antenna tuner's instruction manual for installation and antenna connection details.

• **Setting example:**

For mobile operation

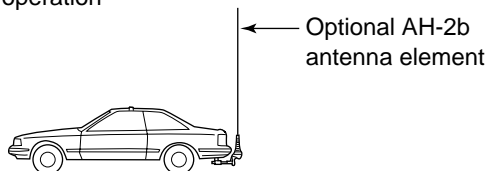

For outdoor operation

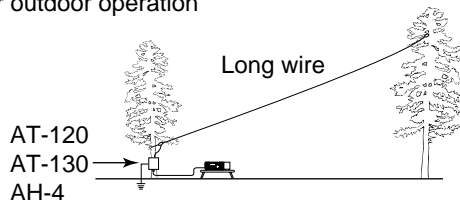

⚠ WARNING: HIGH VOLTAGE!
NEVER touch the antenna element while tuning or transmitting.

NEVER operate the AT-120, AT-130 or AH-4 without an antenna wire. The tuner and transceiver will be damaged.

NEVER operate the AT-120, AT-130 or AH-4 when it is ungrounded.

Transmitting before tuning may damage the transceiver. Note that the AT-120, AT-130 or AH-4 cannot tune when using a $\frac{1}{2} \lambda$ long wire or multiple of the operating frequency.

TUNER OPERATION

Tuning is required for each frequency. **Be sure** to re-tune the antenna before transmitting when you change the frequency—even slightly.

• **Tuner type setting** (p. 32)

- ① Push [PWR] for 1 sec. to turn power OFF.
- ② Enter *initial set mode*.
 - Turn power ON while pushing and holding [SET].
- ③ Push [UP ▲] or [▼ DN] to select [TUNER].
- ④ Selects connected antenna tuner type by rotating the channel selector.
 - no : no antenna tuner is selected.
 - 4 : AH-4 is selected.
 - 12 : AT-120 is selected.
 - 13 : AT-130 is selected.
- ⑥ Push [PWR] for 1 sec. to turn power OFF.
- ⑦ Push [PWR] to turn power ON again.

• **MANUAL TUNING**

- ① Set the desired channel.
- ② Push [TUNER] to start tuning.
 - “[TUNE]” blinks and “CW” appears while tuning.

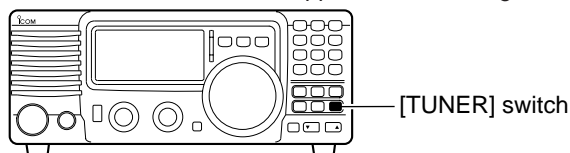

- ③ “[TUNE]” lights constantly when tuning is completed. (except when AT-120 is connected; the indicator goes out)
 - When the connected wire cannot be tuned, the “[TUNE]” goes out, the antenna tuner is bypassed and the antenna wire is connected to the antenna connector on

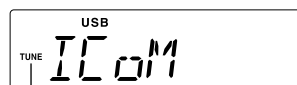

Tuning indicator;
 Blinks: While tuning
 Appears: Tune is completed
 Disappears: Tune is not completed
 (When AT-120 is connected, the indicator disappears even when tuned completely.)

the transceiver directly.

- ④ To bypass the antenna tuner manually, push [TUNER]. (AH-4 only; starts tuning again when AT-120 or AT-130 is connected)

■ Functions for receive

◇ RIT function

The RIT (Receive Incremental Tuning) function compensates for off-frequencies of communicating stations. The function shifts the receive frequency up to 1.2 KHz without moving the transmit frequency.

- Rotate the RIT control to cancel the off-frequencies.
 - “**RIT**” appears on the display.
 - The transmit frequencies are not shifted.

- To cancel the RIT function, rotate the RIT control to the center position.
 - “**RIT**” disappears.

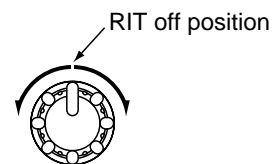

◇ Preamp

The preamp amplifies received signals in the front end circuit to improve the S/N ratio and sensitivity. Turn this function ON when receiving weak signals.

- ➔ Push [P.AMP] to turn the the preamp ON and OFF.
 - Preamp functions below 1.6 MHz, but sensitivity may be reduced in some cases.

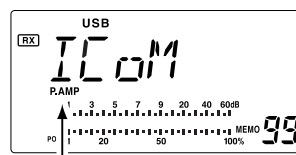

Appears when the preamp is ON.

◇ Attenuator

The attenuator prevents desired signals from distorting when very strong signals are near the desired frequency or when very strong electric fields, such as from broadcasting stations, are near your location.

- ➔ Push [ATT] to turn the 20 dB attenuator function ON and OFF.
 - “ATT” appears when the attenuator is turned ON.

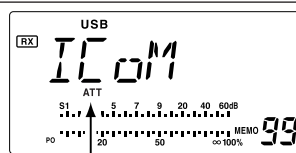

Appears when the attenuator is ON.

◇ Noise blanker

The *noise blanker* reduces pulse-type noise such as that generated by automobile ignition systems.

- Push the [NB] switch to turn the noise blanker ON.
 - [NB] indicator appears.
- Push the [NB] for 1 sec. to enter the noise blanker level setting condition.
- Rotate the channel selector to adjust the noise blanker level.
- Push [NB] to exit the setting condition.
- Push [NB] again to turn the noise blanker function OFF.
 - [NB] indicator disappears.

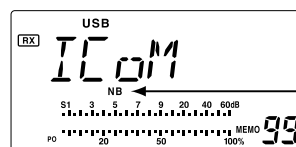
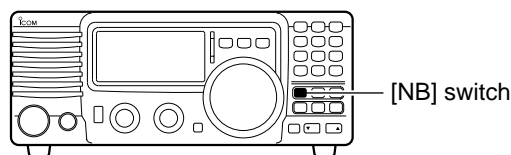

Appears when the noise blanker is ON.

- When using the noise blanker, received signals may be distorted if they are excessively strong.
- The noise blanker function in AM mode can be deactivated depending on *initial set mode* setting. (p. 31)

4 OPERATION

◇ Meter peak hold

The meter peak hold function freezes the highest displayed bar segment in any meter function for about 0.5 sec. so that you can more easily read the meter. This function can be turned ON and OFF in *initial set mode*. (p. 31)



Initial reception of a signal results in an S-meter reading of 40 dB.

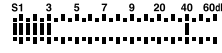

The highest indicated bar remains displayed for 0.5 sec. even when the signal strength decreases.

◇ IF shift function

The IF shift function electronically narrows the passband frequency of the IF (intermediate frequency) and cuts out higher or lower frequency components of the IF to reject interference. The function shifts the IF frequency up to ± 1.2 KHz in SSB/CW/RTTY modes and up to ± 250 Hz in CW-narrow/RTTY narrow modes. The IF shift is not available in AM mode.

IF SHIFT OPERATION EXAMPLE

- Adjust the [SHIFT] control for a minimum interference signal level.
- When IF shift is used, the audio tone may be changed.
- Set the IF shift control to its center position when there is no interference.

Both controls at center position

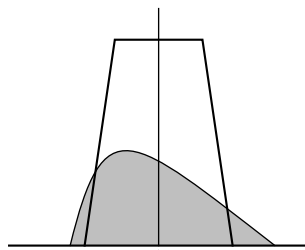
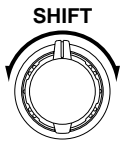

IF center frequency

Cutting a lower passband

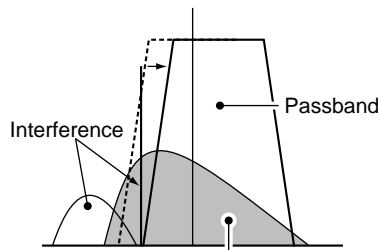
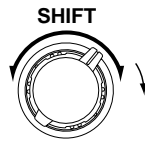

Desired signal

Cutting higher passbands

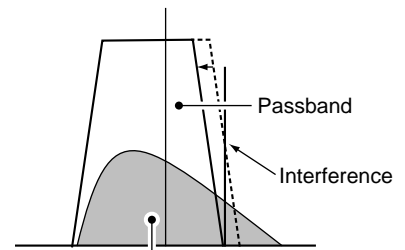
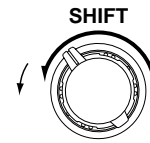

Desired signal

Filter selection

The filter selection switches the IF passband width as shown in the table at right.

The filter selection is for temporal setting.

- ① Select the desired mode programmed channel. (p. 13)
- ② Push [SET] for 1 sec. to enter *quick set mode*.
- ③ Push [UP ▲] or [▼DN] several times until "FILTER" appears on the display.
- ④ Rotate the channel selector to select desired passband width.
 - Either "W" or "N" does not appear while the normal filter is selected.
 - "W" appears when the wide filter is selected.
 - "N" appears when the narrow filter is selected.
- ⑤ Push [SET] to exit *quick set mode*.

Optional filter variations

Name	Band width	Mode
FL-52A	500 Hz/-6dB	CW/RTTY-N
FL-53A	250 Hz/-6dB	CW/RTTY-N
FL-96	2.8 KHz/-6dB	SSB-W
FL-222	1.8 KHz/-6dB	SSB-N
FL-257	3.3 KHz/-6dB	SSB-W

When an optional filter is installed, set the optional filter in *initial set mode*. An optional filter is not selected by default.

Filter construction (Rx)

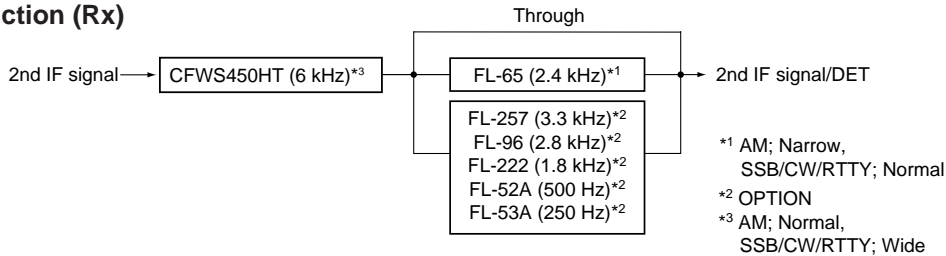

Filter selection table

		no	FL-52A	FL-53A	FL-96	FL-222	FL-257
SSB	WIDE	6 kHz*	6 kHz*	6 kHz*	6 kHz* 2.8 kHz	6 kHz*	6 kHz* 3.3 kHz
	NORMAL	2.4 kHz	2.4 kHz	2.4 kHz	2.4 kHz	2.4 kHz	2.4 kHz
	NARROW	—	500 Hz*	250 Hz*	—	1.8 kHz*	—
CW	WIDE	6 kHz*	6 kHz*	6 kHz*	6 kHz* 2.8 kHz	6 kHz*	6 kHz* 3.3 kHz
	NORMAL	2.4 kHz	2.4 kHz	2.4 kHz	2.4 kHz	2.4 kHz	2.4 kHz
	NARROW	—	500 Hz	250 Hz	—	1.8 kHz	—
RTTY	WIDE	6 kHz*	6 kHz*	6 kHz*	6 kHz* 2.8 kHz	6 kHz*	6 kHz* 3.3 kHz
	NORMAL	2.4 kHz	2.4 kHz	2.4 kHz	2.4 kHz	2.4 kHz	2.4 kHz
	NARROW	—	500 Hz	250 Hz	—	1.8 kHz	—
AM	WIDE	—	—	—	—	—	—
	NORMAL	6 kHz	6 kHz	6 kHz	6 kHz	6 kHz	6 kHz
	NARROW	2.4 kHz	2.4 kHz 500 Hz*	2.4 kHz 250 Hz*	2.4 kHz 2.8 kHz*	2.4 kHz 1.8 kHz*	2.4 kHz 3.3 kHz*

*Can be used when the expanded filter selection is turned on in the *initial set mode*. (see next page)

Filter setting

When an optional filter is installed, set the optional filters in *initial set mode*. Optional filters are not selected by default. (p. 33)

Optional filter setting

- ① While pushing and holding [SET], push [PWR] to enter *initial set mode*.
- ② Push [UP ▲] or [▼ DN] several times until "FIL" appears on the display.
- ③ Rotate the channel selector to select the installed filter.
 - "no," "52A," "53A," "96," "222" and "257" indicate no optional filter, FL-52A, FL-53A, FL-96, FL-222 and FL-257, respectively for 455 kHz IF filter selection.
- ④ Push [PWR] for 1 sec. to exit *initial set mode*.

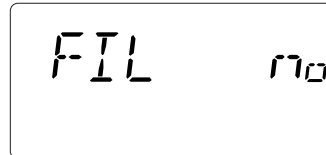

Expanded filter selection

The selectable filter combinations can be expanded by setting the expanded filter selection to ON. Then extra wide or narrow filter can be selected on desired mode.

- ① While pushing and holding [SET], push [PWR] to enter *initial set mode*.
- ② Push [UP ▲] or [▼ DN] several times until "EXP FIL" appears.
- ③ Rotate the channel selector to turn the expanded filter selection 'on'.
 - If 'on' is selected, the expanded filter selection can be used.

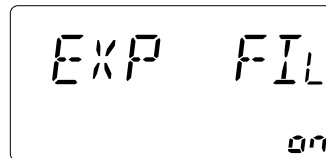

Wide/narrow filter selection

- ④ Push [UP ▲] several times until "WIDE **" or "NAR **" appears on the display.
- ⑤ Push [MODE] several times to select the desired mode.
- ⑥ Rotate the channel selector to select a filter.
- ⑦ Repeat steps ⑤ and ⑥ to select IF filters for other modes, if desired.
 - The filter combinations are stored depending on operating modes.

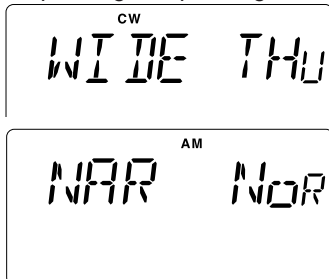

- ⑧ Push [PWR] for 1 sec. to exit *initial set mode*.

Wide filter setting table

	no	FL-52A	FL-53A	FL-96	FL-222	FL-257
SSB	no	no	no	96 (2.8 kHz)	no	257 (3.3 kHz)
	THU (6 kHz)	THU (6 kHz)	THU (6 kHz)	THU (6 kHz)	THU (6 kHz)	THU (6 kHz)
CW	no	no	no	96 (2.8 kHz)	no	257 (3.3 kHz)
	THU (6 kHz)	THU (6 kHz)	THU (6 kHz)	THU (6 kHz)	THU (6 kHz)	THU (6 kHz)
RTTY	no	no	no	96 (2.8 kHz)	no	257 (3.3 kHz)
	THU (6 kHz)	THU (6 kHz)	THU (6 kHz)	THU (6 kHz)	THU (6 kHz)	THU (6 kHz)
AM	—	—	—	—	—	—

■ : default

Narrow filter setting table

	no	FL-52A	FL-53A	FL-96	FL-222	FL-257
SSB	—	no	no	—	222 (1.8 kHz)	—
		52A (500 Hz)	53A (250 Hz)			
CW	—	52A (500 Hz)	53A (250 Hz)	—	222 (1.8 kHz)	—
RTTY	—	52A (500 Hz)	53A (250 Hz)	—	222 (1.8 kHz)	—
AM	NOR (2.4 kHz)	NOR (2.4 kHz)	NOR (2.4 kHz)	NOR (2.4 kHz)	NOR (2.4 kHz)	NOR (2.4 kHz)
		52A (500 Hz)	53A (250 Hz)	96 (2.8 kHz)	222 (1.8 kHz)	257 (3.3 kHz)

■ : default

■ Function for CW

◇ Connection for CW

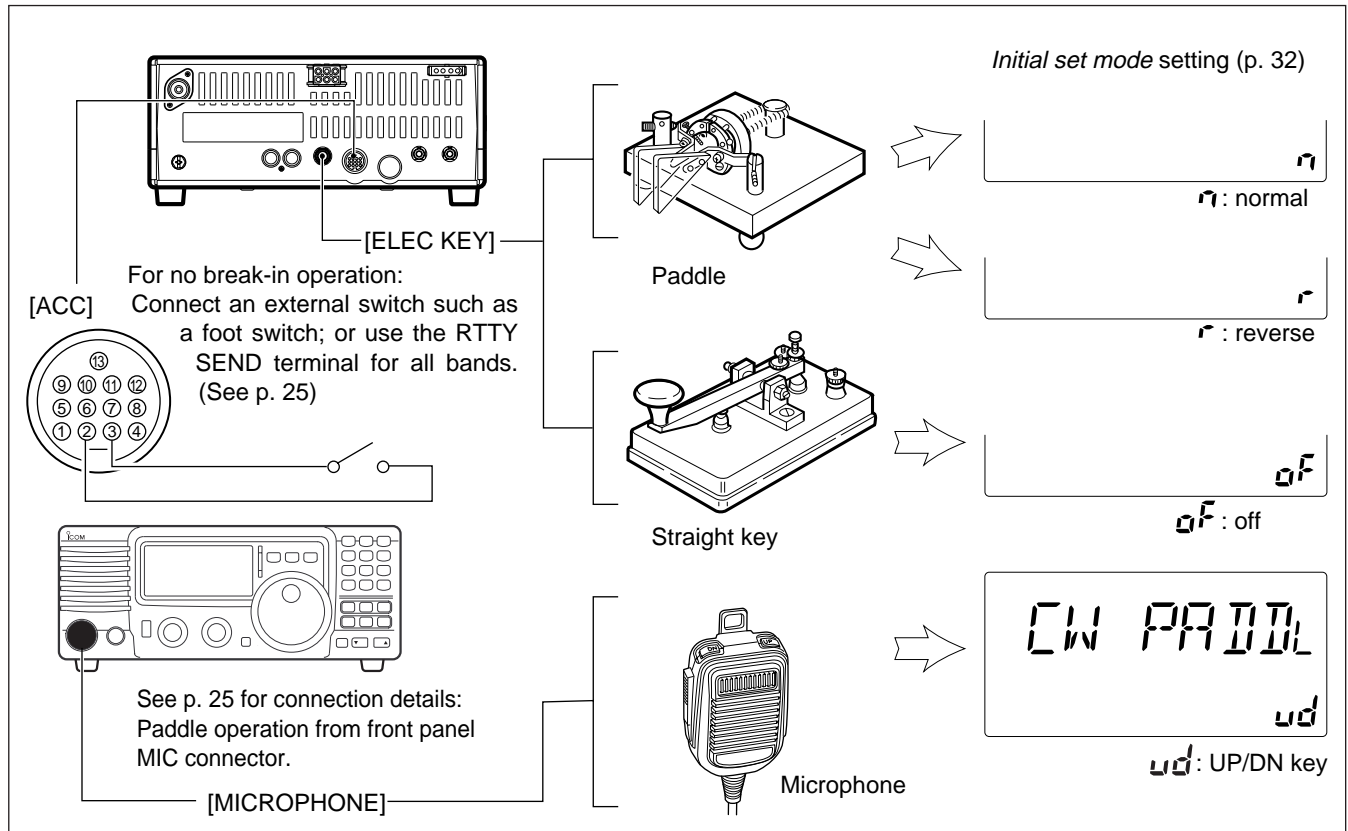

◇ CW operation

- ① Connect a paddle or straight key as above.
- ② Select CW (or CW-REV) programmed channel.
- ③ Set CW break-in operation as semi break-in, full break-in or OFF. (see p. 30)
 - Push [SET] for 1 sec. to enter *quick set mode*.
 - Push [UP▲] or [▼DN] several times until "BK-IN" appears, then rotate the channel selector to select the desired condition:
 FL: full break-in
 SE: semi break-in
 oF: no break-in
- ④ Set the CW delay time when semi break-in operation is selected. (see p. 30)
 - Push [SET] for 1 sec. to enter *quick set mode*; push [UP▲] or [▼DN] several times until "BK-DELAY" appears, then rotate the channel selector to select the desired delay time.

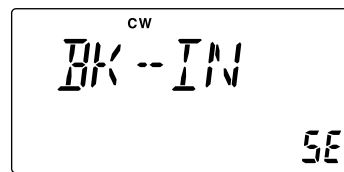

CW mode and semi break-in operation is selected.

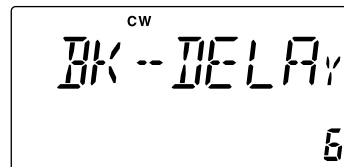

Delay time of 6 dots is selected in quick set mode for semi break-in operation.

4 OPERATION

◇ CW pitch control

The received CW audio pitch and monitored CW audio pitch can be adjusted to suit your preferences (300 to 900 Hz) without changing the operating frequency.

- ① Push [SET] for 1 sec. to enter quick set mode.
- ② Push [▲UP]/[▼DN] one or more times until "CW PITCH" appears, then rotate the main dial to set the desired pitch. (p. 29)

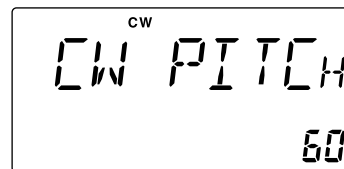

This shows the default setting for the CW pitch control (600 Hz).

◇ CW reverse mode

The CW-R (CW Reverse) mode receives CW signals with a reverse side CW carrier point like that of LSB and USB modes. Use this mode when interference signals are near the desired signal and you want to change the interference tone.

- ① Push [MODE] one or more times to select CW mode.
- ② Push [MODE] for 1 sec. to switch between CW and CW-R modes.

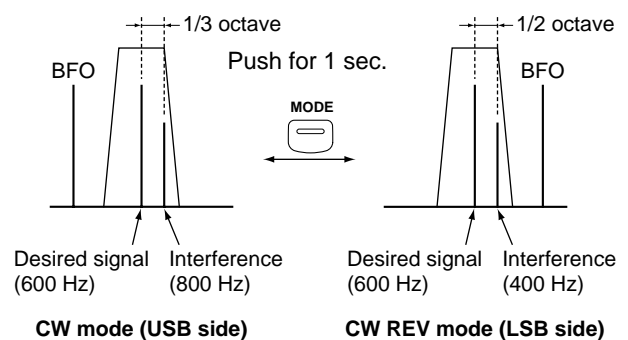

◇ Electronic CW keyer

The IC-78 has an electronic keyer. Both keying speed and weight (the ratio of dot : space : dash) can be set in *quick set mode*.

•Setting the electronic keyer

- ① Push [MODE] one or more times to select CW mode.
- ② While pushing and holding [SET], push [PWR] to enter *initial set mode*.
- ③ Push [▲UP]/[▼DN] one or more times until "CW PADDL" appears, then rotate the main dial to select the paddle type.
 - When "ud" is selected, the up/down switches on the microphone can be use as a paddle.
 - When using up/down switches as a paddle, squeeze keying function is not available.
- ④ Push [▲UP]/[▼DN] one or more times until "KEY RAT" appears, then rotate the main dial to select the desired weight.
 - Key weight can be selected from 2.8 to 4.5.
- ⑤ Push [▲UP]/[▼DN] one or more times until "KEY SPD" appears, then rotate the main dial to select the desired weight.
 - Key weight can be select from 6 to 60.

Paddle operation from front panel MIC connector

Connect a CW paddle as at right to operate an electronic keyer from the front panel MIC connector.

KEYING WEIGHT EXAMPLE: morse code "K"

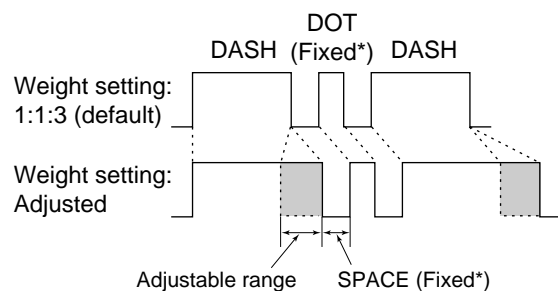

*SPACE and DOT length can be adjusted with "KEY SPD" in the quick set mode only.

Paddle operation

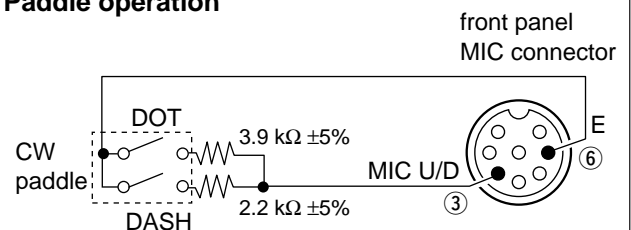

- This function is available from the front panel mic connector only.
- Be sure to select item "n," "r," or "oF" in CW PADDL in initial set mode.
- Connect straight key to "DOT" side.

■ Function for RTTY

◇ Connection for RTTY (FSK)

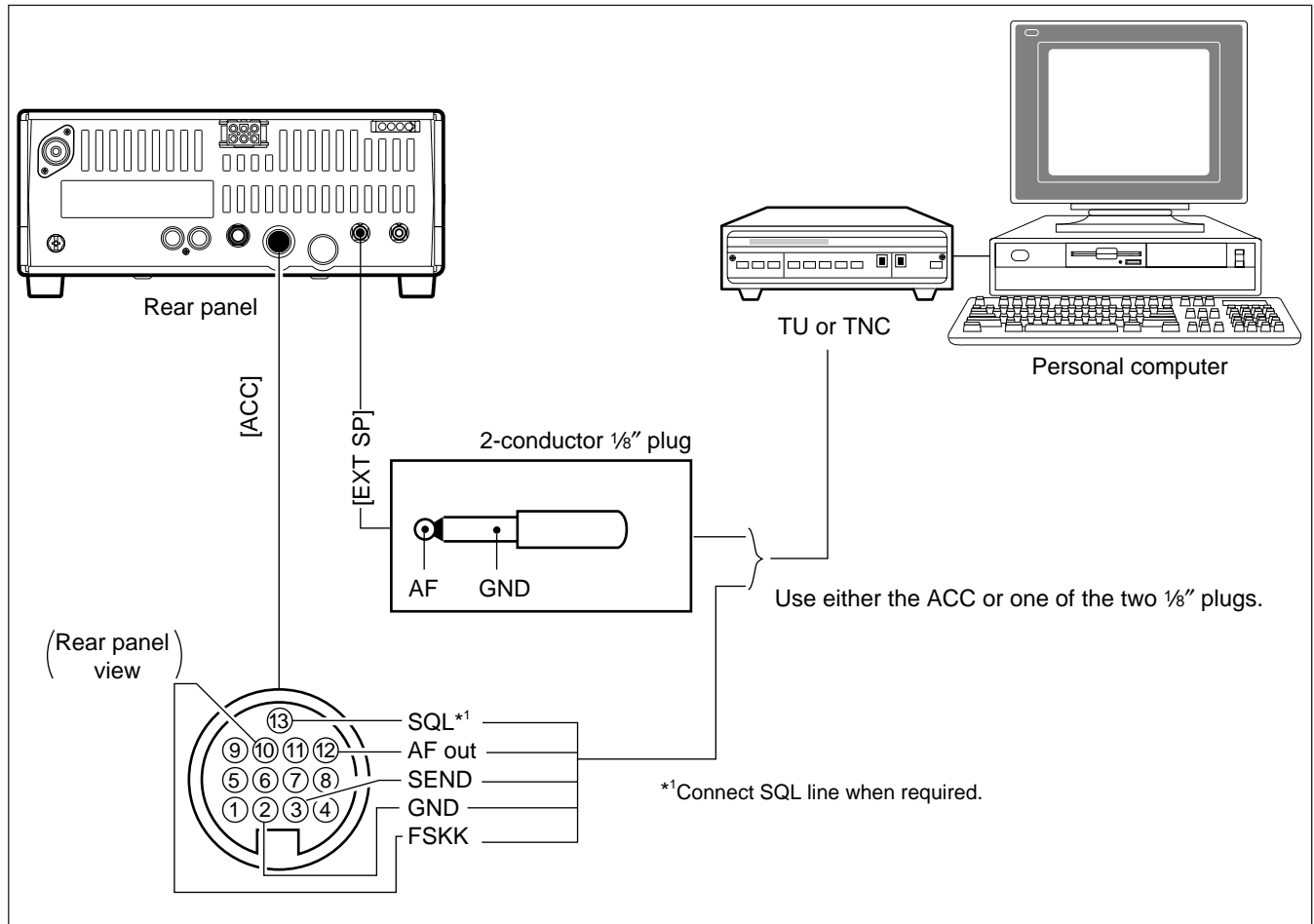

◇ Connection for AFSK

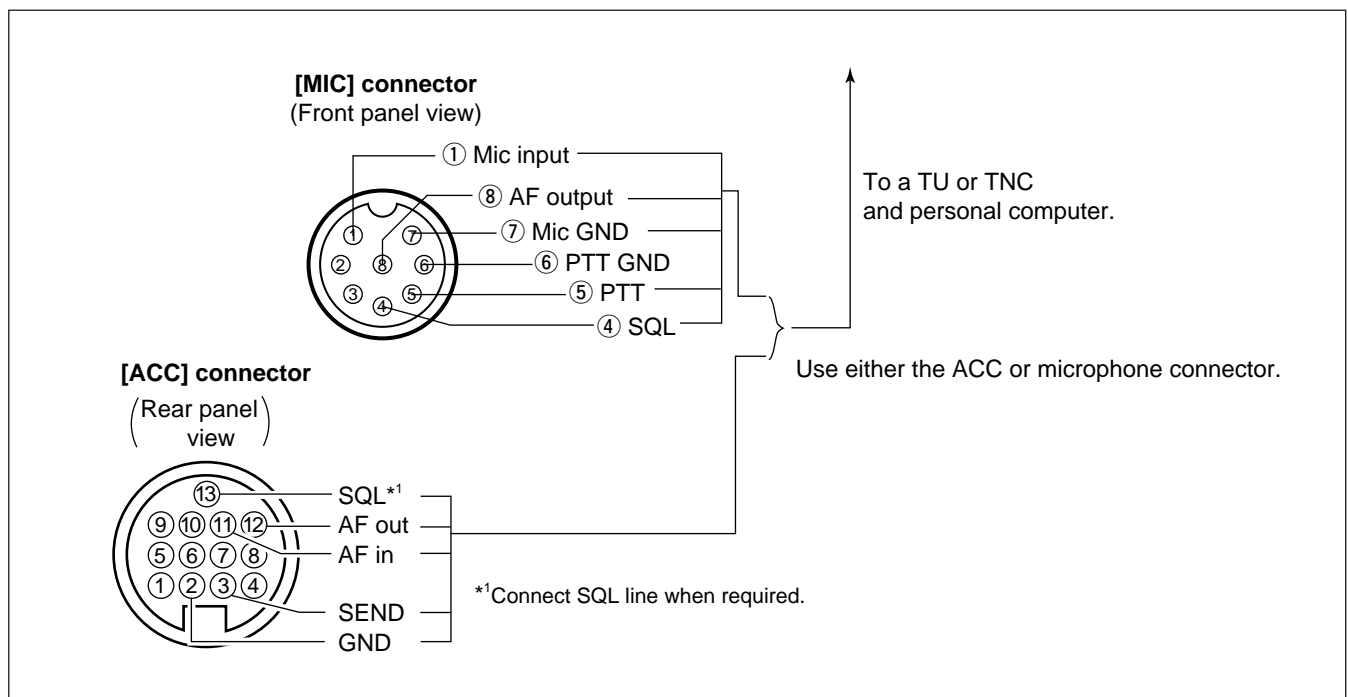

4 OPERATION

◇ RTTY (FSK) operation

- ① Connect a terminal unit as at p. 25.
- ② Select RTTY (or RTTY-R) mode with [MODE].
- ③ Select the desired FSK tone and shift frequencies as below.
- ④ Set the desired frequency with the channel selector.
- ⑤ Operate the connected PC or TNC (TO).

PRESETTING FOR RTTY

• Tone frequency

- ① Push [SET] for 1 sec. to enter *quick set mode*.
- ② Push [▲UP]/[▼DN] several times until "TON 2125" appears, then rotate the channel selector to select the desired tone frequency.

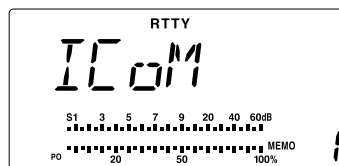

RTTY mode is selected.

• Shift frequency

- ① Push [SET] for 1 sec. to enter *quick set mode*.
- ② Push [▲UP]/[▼DN] several times until "SIFT 170" appears, then rotate the channel selector to select the desired tone frequency.

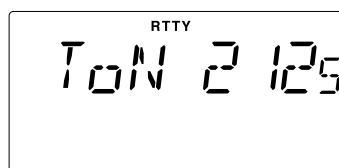

RTTY mark frequency is set to 2125 Hz. 2125, 1615 and 1275 Hz are available.

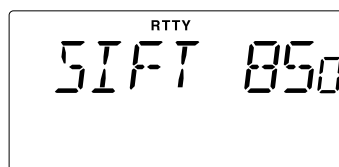

RTTY shift frequency is set to 850 Hz. 850, 425, 200 and 170 Hz are available.

• RTTY reverse mode

Received characters are occasionally garbled when the receive signal is reversed between MARK and SPACE. This reversal can be caused by incorrect TNC connections, settings, commands, etc.

To receive a reversed RTTY signal correctly, select RTTY-R (RTTY reverse) mode.

- Push [MODE] for 1 sec. to select RTTY-R (RTTY reverse) mode.

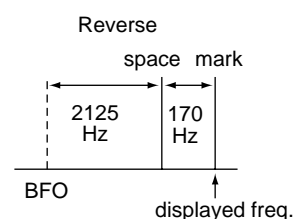
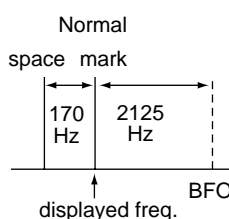

◇ RTTY (AFSK) operation

- ① Connect a terminal unit as on p. 25.
- ② Select SSB (LSB) mode with [MODE].
 - Generally, LSB is used on the HF bands.
- ③ Select the desired FSK tone/shift frequencies and keying polarity the same way as FSK operation.
- ④ Set the desired frequency with the main dial.
- ⑤ Operate the connected PC or TNC (TO).

■ Channel comment programming

The IC-78 has a capability to assign up to 8-character channel comments for each operating channel. This provides easy recognition of channel usage, or station names, etc.

- ① Select the desired channel by pushing [▼ DN]/[UP ▲], rotating the channel selector, or using the keypad. (p. 13)
- ② Push [FC] to select channel comment indication, if desired.
- ③ Push [ENT] for 1 sec. to enter channel comment programmable mode.
 - 1st digit blinks
- ④ Push corresponding keys to enter desired characters. (see the following chart)
 - Push [▼ DN]/[UP ▲], or rotate the channel selector to move the cursor to select the next character, or to change the digit.
- ⑤ Push [ENT] for 1 sec. to store the channel comment.

• Channel comment programming example

Push [ENT] for 1 sec.

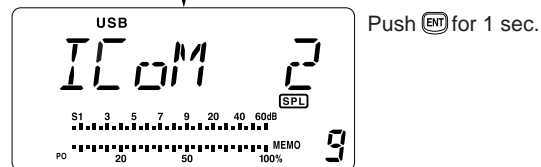
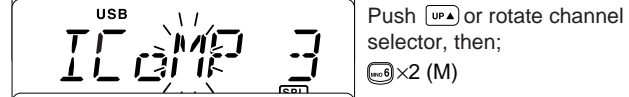
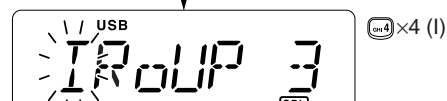
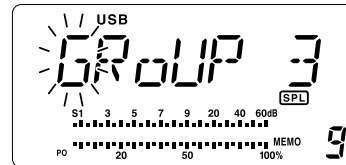

◇ Corresponding characters

KEY	Assignable characters	KEY	Assignable characters	KEY	Assignable characters
[1]	1 (1), (space), ' (')	[2]	2 (2), A (A), B (B), C (C)	[3]	3 (3), D (D), E (E), F (F)
[4]	4 (4), G (G), H (H), I (I)	[5]	5 (5), J (J), K (K), L (L)	[6]	6 (6), M (M), N (N), O (O)
[7]	7 (7), P (P), R (R), S (S)	[8]	8 (8), T (T), U (U), V (V)	[9]	9 (9), W (W), X (X), Y (Y)
[0]	0 (0), Q (Q), Z (Z)	[TXF]	(space w/change digit)	[0]	0 (0), Q (Q), Z (Z)

■ General

Set mode is used for programming infrequently changed values or conditions of functions. The IC-78 has 2 separate set modes: *quick set mode* and *initial set mode*.

◇ Quick set mode operation

- ① While power is ON, push [SET] for 1 sec.
 - Quick set mode is selected and one of its items appears.
- ② Push [UP ▲] or [▼ DN] to select the desired item.
- ③ Rotate the main dial to set the values or conditions for the selected item.
- ④ Repeat ② and ③ to set other items.
- ⑤ To exit quick set mode, push [SET] momentarily.

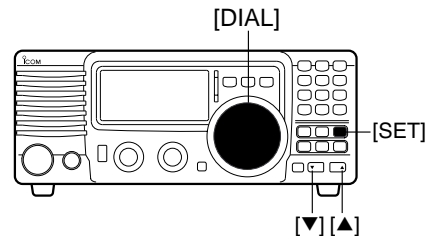

[DISPLAY EXAMPLE: QUICK SET MODE]

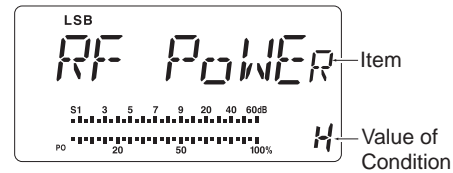

◇ Initial set mode operation

- ① Push [PWR] for 1 sec. to turn power OFF.
- ② While pushing and holding [SET], push [PWR] to turn power ON.
 - Initial set mode is selected and one of its items appears.
- ③ Push [UP ▲] or [▼ DN] to select the desired item.
- ④ Rotate the main dial to set the values or conditions for the selected item.
- ⑤ Repeat ③ and ④ to set other items.
- ⑥ To exit initial set mode, push [PWR] for 1 sec. to turn power OFF.
- ⑦ Push [PWR] to turn power ON again.
 - The conditions selected in initial set mode are now effective.

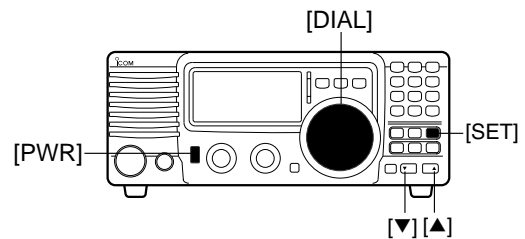

[DISPLAY EXAMPLE: INITIAL SET MODE]

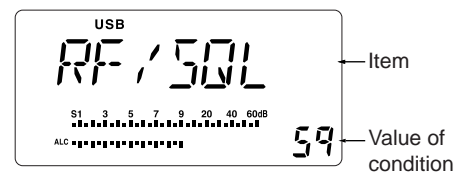

■ Quick set mode items

•RF power

This item adjusts the RF output power. The RF output power can be adjusted from L, 1 to 99 and H by indication, however, it can be adjusted continuously.

•The default is H (maximum power).

Note that while adjusting the output power, the power meter is displayed automatically.

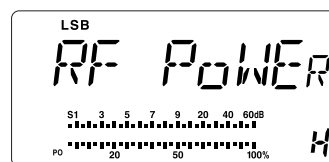

•Mic gain

This item adjusts microphone gain from 0 to 99 and H by indication, however, it can be adjusted continuously.

The default is 50.

Note that while adjusting the mic gain, the ALC meter is displayed automatically.

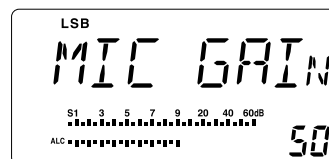

•Filter

This item selects filter bandwidth from wide, normal, and narrow.

The default is normal (no indication appears).

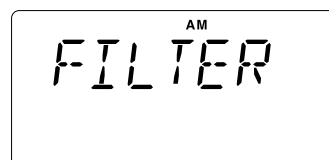

•VOX function

This item selects the VOX function from ON and OFF.

The default is of (OFF).

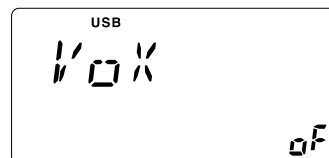

•VOX gain

This item adjusts the VOX gain for the VOX (voice activated transmit) function.

The default is 50.

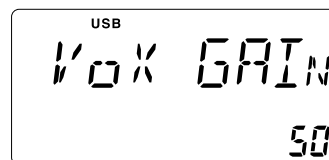

•VOX delay

This item adjusts VOX (voice activated transmit) delay time. The delay time can be adjusted from 0 to 2 sec. in 0.1 sec. units.

The default is 10 (1.0 sec).

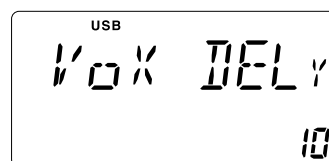

•Anti VOX level

This item adjusts the ANTI-VOX gain for the VOX (voice activated transmit).

The default is 50.

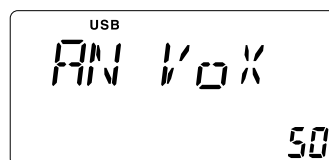

•CW pitch

This item adjusts CW pitch. CW pitch is adjustable from 300 Hz to 900 Hz in 10 Hz steps.

The default is 60 (600 Hz).

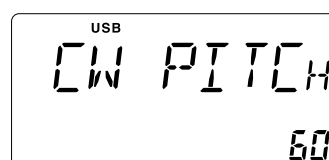

■ Quick set mode items— (continued)

•BK-IN

This item selects break-in type for CW operation.

There are three selectable values:

oF : No break-in operation available (default).

SE : Semi break-in operation available.

FL : Full break-in operation available.

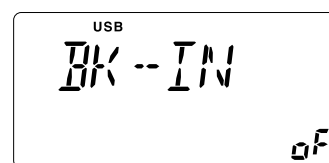

•BK-IN delay

This item adjusts break-in delay time for CW semi break-in operation. The delay time is selectable from 2.0 to 13 (dots).

The default is 7.

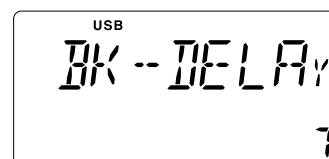

•Key speed

This item adjusts the CW key speed. The key speed can be selected from 6 to 60* wpm.

The default is 20 wpm.

*40, 44, 47, 50, 52, 54, 56, 57, 59 cannot be selected.

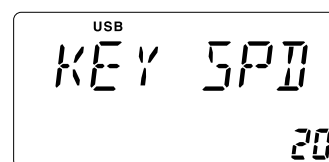

•Key ratio

This item sets the CW key ratio (or weight). The ratio can be selected from 2.8 to 4.5.

The default is 30 (3.0).

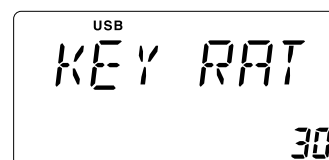

•RTTY mark tone

This item selects RTTY tone. There are 3 selectable values: 1275, 1615 and 2125 Hz.

The default is 2125 Hz.

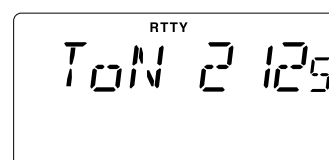

•RTTY shift

This item adjusts RTTY shift. There are 4 selectable values: 170, 200, 425 and 850.

The default is 170 Hz.



•Dimmer

This item selects LCD back light brightness. There are 3 selectable values: Off, Low and High.

The default is HI (High).



•Tuning step

This item selects tuning step for the channel selector's tuning.

The default is 1 k (1 kHz).

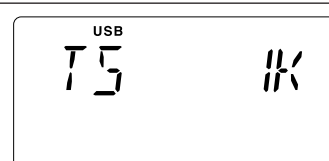

■ Initial set mode items

•RF/SQL control action

Select [RF/SQL] control action from RF/squelch, automatic (acts as squelch in AM modes; as RF in SSB/CW/RTTY modes), or the squelch. (See p. 15)
The default is Sq (squelch).

RF / SQL
59

•Beep

A beep sounds each time a switch is pushed to confirm it. This function can be turned OFF for silent operation.
The default is on.

BEEP
on

•Beep level

Adjusts the confirmation beep level from 1 to 99.
The default is 50.

BP LEVEL
50

•Side-tone level

Adjusts the CW side-tone level from 1 to 99.
The default is 30.

CW-T LVL
30

•Meter peak hold

Selects meter peak hold function on or off.
The default is on.

P-Hold
on

•Scan speed

Selects scanning speed from High and Low.
The default is HI (High).

SCN SPD
HI

•Scan resume

Selects the scan resume function ON or OFF.
ON: Resumes 10 sec. after stopping on a signal (or 2 sec. after a signal disappears);
OFF: Does not resume after stopping on a signal.
The default is on.

SCN RS
on

•AM Noise blanker

When this item is set to ON, the noise blanker function is available in AM mode. This is useful when communicating in AM mode (the noise blanker function should not be used when listening to regular AM broadcasts as it may degrade the receive audio).
The default is on.

AM NB
on

■ Initial set mode items— (continued)

•Key type

Selects the CW paddle type. Four selections are available.

- n : normal (for electronic keyer use)
 - r : reverse (for electronic keyer use)
 - oF : Turns OFF the electronic keyer (for straight key use)
 - ud : For using the microphone's [UP]/[DN] keys instead of the paddle.
- The default is n (normal).

CW PADD
n

•Tuner type

Selects the connected antenna tuner type. Four selections are available.

- no : No optional tuner is connected.
 - 4 : When AH-4 is connected.
 - 12 : When AT-120 is connected.
 - 13 : When AT-130 is connected.
- The default is no.

TUNER
no

•Number of maximum memory channels

Sets number of programmable memory channels from 1 to 99.
The default is 99.

MAX M-CH
99

•CI-V baud rate

Sets the data transfer rate. When "Auto" is selected, the baud rate is automatically set according to the connected controller or remote controller.
The default is At (Auto).

CI-V BAUD
At

•CI-V address

To distinguish equipment, each CI-V transceiver has its own Icom standard address in hexadecimal code. The IC-78's address is 62.

When 2 or more IC-78s are connected to an optional CT-17 CI-V LEVEL CONVERTER, rotate the main dial to select a different address for each IC-78 in the range 01H to 7FH.

The default is 62.

CI-V ADDR
62

•CI-V Transceive

Transceive operation is possible with the IC-78 connected to other Icom HF transceivers or receivers. When "on" is selected, changing the frequency, operating mode, etc. on the IC-78 automatically changes those of connected transceivers (or receivers) and vice versa.

The default is on.

CI-V TRN
on

•CI-V 731 mode

When connecting the IC-78 to the IC-735 for transceive operation, you must change the operating frequency data to 4 bytes.

- This item MUST be set to "on" when operating the transceiver with the IC-735.

The default is oF (off).

CI-V 731
oF

■ Initial set mode items— (continued)

•OPTION Filter

When an optional IF filter is installed, this selection is necessary, otherwise the filters cannot be selected. Selections available are FL-96, FL-222, FL-52A, FL-53A, FL-257 and none (default). See p. 21 for usable filters for each mode and see p. 38 for filter installation.



FIL no

•Expand Filter

When an optional IF filter is installed, this selection expands filter and filter selection (W/N) key combination in operating mode independently. The default is oF (off).

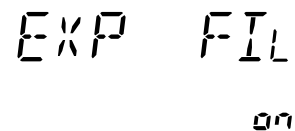

EXP FIL
on

•Filter select (Wide)

When an optional IF filter is installed, you can arrange the wide filter selection. (p. 22)

This item appears only when the Expand Filter, as above, is turned ON.



^{CW}
WIDE THU

•Filter select (Narrow)

When an optional IF filter is installed, you can arrange the narrow filter selection. (p. 22)

This item appears only when the Expand Filter, as above, is turned ON.

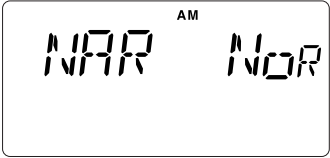

^{AM}
NAR NoR

INTRODUCTION

Extra features, explained in this section, are available only on some versions of the IC-78. Therefore, the instructions in this section are not necessary for some versions.

VFO operation

Entering VFO mode

To enter VFO mode, push [FC] for 1 sec.

- VFO indicator appears.
- In the VFO mode, channel comment cannot be indicated.

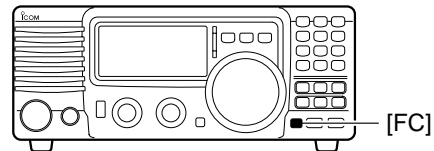

Tuning

The transceiver has several ways of tuning for temporal operation as follows;

Tuning with the channel selector

By rotating the channel selector, operating frequency changes in the desired tuning step, set in the *quick set mode*. (p. 30)

This is the most convenient way when searching for signals around the pre-programmed frequency.

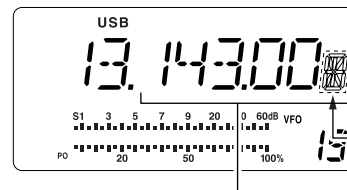

Appears only when 1 Hz tuning step is selected.

Changing digit; according to selected tuning step

Tuning with the keypad

Enter the frequency as follows.

Start

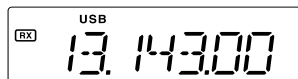

To set to 25.118 MHz



To set to 706 KHz (0.706 MHz)



To set to 5.0000 MHz



To change 13.1430 MHz to 13.3190 MHz

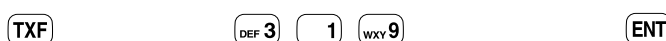

➔ For duplex operation setting, push [TXF] then set the transmit frequency, after the receive frequency is set.

◇ Channel programming

The programmed frequencies, both transmit and receive, in operating channel can be re-programmed from the VFO mode.

• Simplex channel programming

- ① Push [FC] for 1 sec. to enter VFO mode.
- ② Push [▼ DN]/[UP ▲] to select the desired channel.
 - Any channels, even blank channels, can be selected.
 - If you want to select the desired channel with keypad, select the channel before entering VFO mode.
- ③ Tune to the desired receive frequency with the channel selector, or keypad. (p. 34)
 - Selects operating mode and other settings, such as filter selection, RF attenuator, etc., if necessary.
- ④ Push [ENT] for 1 sec. (3 beeps are emitted), to store the frequency into the selected channel.
 - Reprogram the channel comment, if necessary. (p.27)

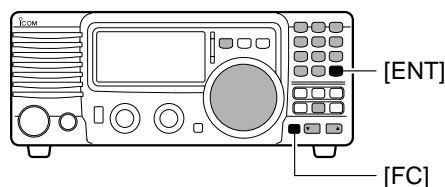

• Split (duplex) channel programming

- ① Store receive frequency as instructed above.
- ② Push [TXF] to indicate the transmit frequency.
 - The "TX" indicator blinks.
- ③ Tune to the desired transmit frequency with the channel selector, or keypad. (p. 34)
- ④ Push [ENT] for 1 sec. (3 beeps are emitted), to store the transmit frequency into the selected channel.
 - The "[SPL]" indicator appears.

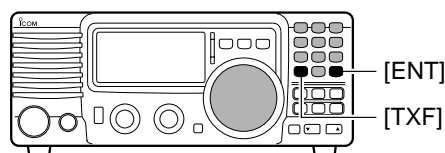

◇ Call channel programming

The programmed frequencies, both transmit and receive, in call channel can also be re-programmed from the VFO mode.

- ➔ Select channel 0 (call channel) with the keypad in the channel mode or [▼ DN]/[UP ▲] in the VFO mode.
 - The channel 0 cannot be selected with the channel selector
 - When the channel 0 is selected with [CALL], the stored frequencies cannot be re-programmed.
 - Pushing [FC] for 1 sec. to enter into VFO mode when channel 0 is selected in channel mode.

- ➔ Set receive or both receive and transmit frequencies, operating mode and other settings as above, then push [ENT] for 1 sec. to store into call channel.

6 EXTRA FEATURES

◇ Channel clearing

If un-necessary channels are available, the stored frequency can be cleared. The cleared channels are skipped in the channel mode operation,

- ① Select desired channel in channel mode. (p. 13)
- ② Enter VFO mode by pushing [FC] for 1 sec.
 - Channel selection with [▼ DN]/[UP ▲] is also possible in the VFO mode.
- ③ Push [0], then [ENT].
- ④ Push [ENT] for 1 sec. (3 beeps are emitted), to clear the selected channel.
 - The “**BLANK**” indicator appears.

Note: Blank channels cannot be selected with [▼ DN]/[UP ▲], and channel selector; can only be selected with the keypad.

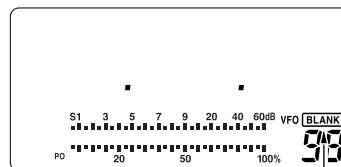

Appears when cleared.

■ 2-Tone alarm operation

The 2-tone alarm is used for instant emergency operation. When the 2-tone alarm function is activated, the call channel (2182 kHz, distress channel, is pre-programmed) is selected automatically, and emits a distress alarm.

◇ Operation

- ➔ Push [TONE] to emit a distress alarm signal for a specified time period from the speaker only.
 - “**ALM**” appears.
 - Push [TONE] again to cancel the distress alarm signal emission.
 - Push [CALL] to return to previous condition.
- ➔ Push [TONE] for 1 sec. to transmit a distress alarm or alarm testing signal for a specified time period.
 - “**ALM**” appears with the transmit indicator.
 - Push [TONE] again to cancel the distress alarm signal transmission.
 - Push [CALL] to return to previous condition.

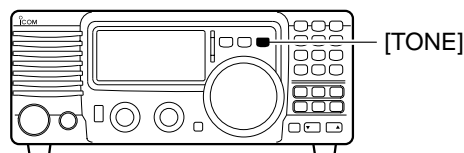

■ Opening the transceiver's case

Follow the case and cover opening procedures shown here when you want to install an optional unit or adjust an internal unit, etc.

CAUTION: DISCONNECT the DC power cable from the IC-78 before performing any work on the transceiver. Otherwise, there is danger of electric shock and/or equipment damage.

- ① Remove the 5 screws from the top of the transceiver and 4 screws from the sides, then lift up the top cover.
- ② Remove the 5 screws from the bottom of the transceiver, then remove the bottom cover.

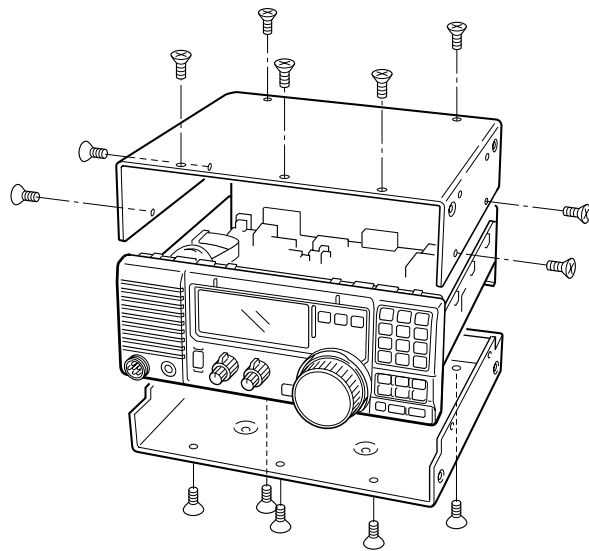

■ Optional bracket and carrying handle

◇ Mounting bracket

An optional IC-MB5 MOBILE MOUNTING BRACKET is available to install the radio under a table, on a wall, in a vehicle, etc.

Select an area to mount the transceiver keeping in mind that the weight of the transceiver is approx. 3.80kg.

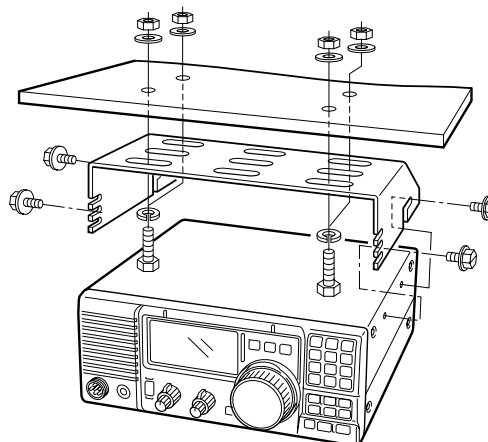

◇ Carrying handle

An optional handle allows you to easily carry and transport the transceiver.

Attach the MB-23 CARRYING HANDLE with the supplied rubber feet as shown.

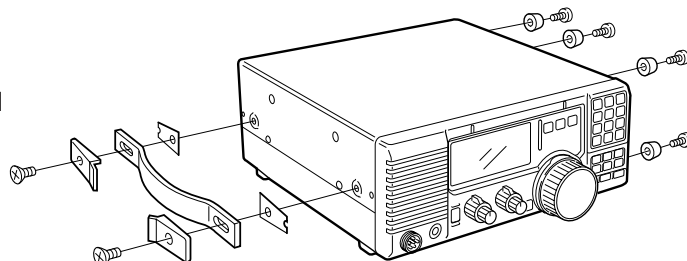

■ CR-338 HIGH STABILITY CRYSTAL UNIT

By installing the CR-338, the total frequency stability of the transceiver will be improved.

- ① Remove the bottom cover as shown in the previous diagram.
- ② Disconnect W2 from J4401 (MAIN unit) and W3 from J4201 (MAIN unit).
- ③ Remove 9 screws from the PLL unit, disconnect P4 from J201 (MAIN unit) and P2 from J401 (MAIN unit), then remove the PLL unit.

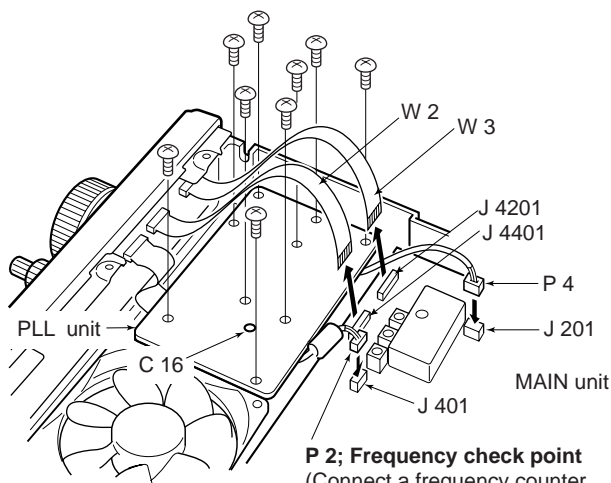

P 2; Frequency check point
(Connect a frequency counter and adjust the frequency to 64.00000 MHz with C 16.)

- ④ Remove the supplied internal crystal and replace with the CR-338.

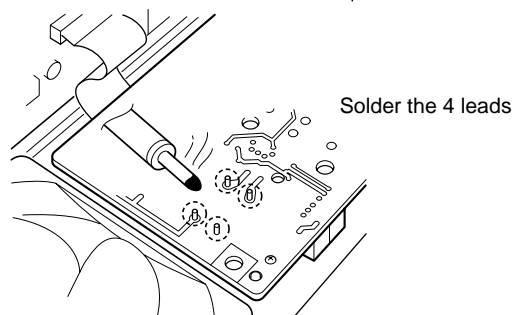
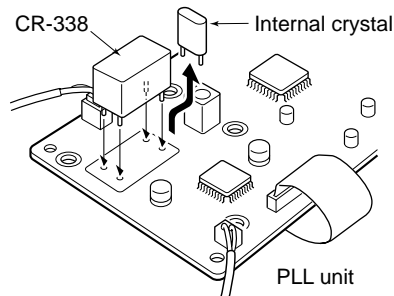

- ⑤ Return the PLL unit, plugs and flat cables to their original positions.
- ⑥ Adjust the reference frequency at C16 using a frequency counter if desired.
 - Connect the frequency counter to P 2 (PLL unit).
- ⑦ Return the bottom cover to its original position.

■ Optional IF filters

Several IF filters are available for the IC-78. You can install 1 filter for 455 KHz IF. Choose the appropriate filter for your operating needs. (pgs, 21, 22)

◆ Installation

- ① Remove the bottom cover as shown on the p. 48.
- ② Remove 7 screws, connection cable p1 from J1, p5 from J701, W4 from J4101 and W5 from J4001 and 2 Tr-clampers as shown in the diagram below.

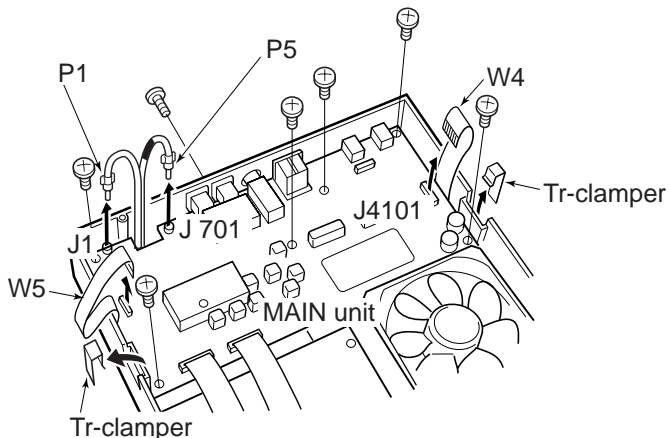

- ③ Install the desired 455 KHz filter as shown in the diagram at right.
- ④ Mount the filter with the supplied washers and nuts.

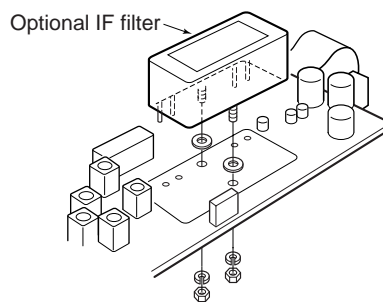

- ⑤ Solder the 4 leads.
- ⑥ Return the MAIN unit and bottom cover to their original positions.

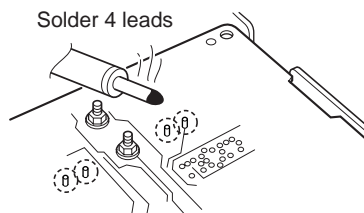

After filter installation, specify the installed filter using *initial set mode*. (p. 33) Otherwise, the installed filter will not function properly.

■ Troubleshooting

The following chart is designed to help you correct problems which are equipment malfunctions.

If you are not able to locate the cause of a problem or solve it through the use of this chart, contact your nearest Icom Dealer or Service Center.

	PROBLEM	POSSIBLE CAUSE	SOLUTION	REF.
POWER	Power does not come on when the [PWR] switch is pushed.	<ul style="list-style-type: none"> • Power cable is improperly connected. • Fuse is blown. 	<ul style="list-style-type: none"> • Re-connect the DC power cable correctly. • Check for the cause, then replace the fuse with the spare one. (Fuses are installed in the DC power cable and the internal PA unit.) 	<p>p. 10</p> <p>p. 40</p>
	No sounds comes out from the speaker.	<ul style="list-style-type: none"> • Volume level is too low. • The squelch is closed. • The transceiver is in transmitting condition. 	<ul style="list-style-type: none"> • Rotate [AF] clockwise to obtain a suitable listening level. • Turn [RF/SQL] to the position which opens the squelch. • Check the SEND line of an external unit, if desired. 	<p>p. 15</p> <p>p. 15</p> <p>p. 5</p>
RECEIVE	Sensitivity is too low, and only strong signals are audible.	<ul style="list-style-type: none"> • The antenna is not connected properly. • Antenna is not properly matched to the operating frequency. • Wrong tuner condition is selected in set mode. • The attenuator is activated. 	<ul style="list-style-type: none"> • Re-connect to the antenna connector. • Push [TUNE] to tune the connected antenna tuner. • Set the proper condition for the connected tuner. • Push [ATT] to turn the attenuator OFF. 	<p>p. 9</p> <p>p. 18</p> <p>p. 32</p> <p>p. 19</p>
	Received audio is unclear or distorted.	<ul style="list-style-type: none"> • Wrong type of mode (emission) is selected. • Noise blanker is turned ON when receiving a strong signal. • The [RIT] control is rotated too far clockwise, or counterclockwise. 	<ul style="list-style-type: none"> • Push [MODE] to select the proper operating mode (emission). • Push [NB] to turn the noise blanker OFF. • Adjust the [RIT] control to receive proper audio output. 	<p>p. 15</p> <p>p. 19</p> <p>p. 19</p>
TRANSMIT	Your signal does not reach as far away as usual.	<ul style="list-style-type: none"> • Antenna tuner is improperly matched to the operating frequency when manual tuning is selected. • CW or RTTY mode is selected for voice transmission. 	<ul style="list-style-type: none"> • Push [TUNE] to tune the connected antenna tuner. • Push [MODE] to select USB, LSB, or AM mode. 	<p>p. 18</p> <p>p. 15</p>
	Transmit signal is unclear or distorted.	<ul style="list-style-type: none"> • Wrong type of mode (emission) is selected. • Microphone is too close to your mouth. 	<ul style="list-style-type: none"> • Push [MODE] to select the proper operating mode (emission). • Speak into the microphone naturally and do not hold the microphone too close to your mouth. 	<p>p. 15</p> <p>p. 15</p>
DISPLAY	The displayed channel does not change properly.	<ul style="list-style-type: none"> • The dial lock function is activated. • A quick set mode is selected. 	<ul style="list-style-type: none"> • Push [LOCK] to turn the lock function OFF. • Push [SET] to exit the quick set mode. 	<p>p. 14</p> <p>p. 28</p>

■ Fuse replacement

If a fuse blows or the transceiver stops functioning, try to find the source of the problem, and replace the damaged fuse with a new, rated fuse.

CAUTION: DISCONNECT the DC power cable from the transceiver when changing a fuse.

The IC-78 has 2 types of fuses installed for transceiver protection.

- DC power cable fuses FGB 20 A
- Circuitry fuse FGB 4 A

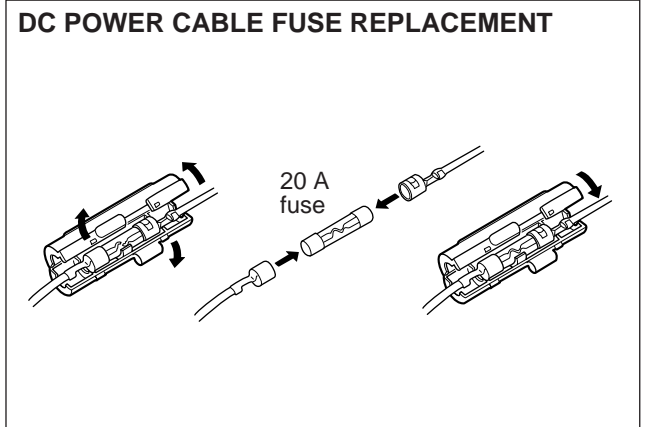

CIRCUITRY FUSE REPLACEMENT

The 13.8 V DC from the DC power cable is applied to all units in the IC-78 through the circuitry fuse. This fuse is installed in the MAIN unit.

- ① Remove the top cover as shown on p. 48
- ② Replace the circuitry fuse as shown in the diagram at right.
- ③ Replace the top cover.

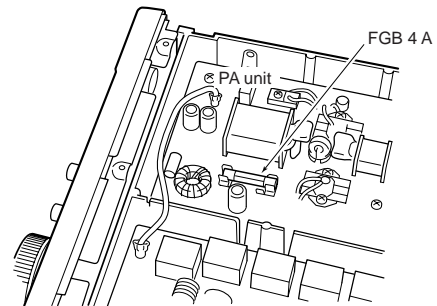

■ Resetting the CPU

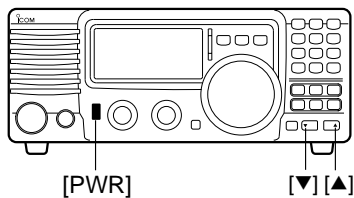

Returns programmed values in both *quick* and *initial set mode* to their defaults.

When first applying power or when the function seems to be displaying erroneous information, reset the CPU as follows:

- ① Make sure transceiver power is OFF.
- ② While pushing [UP ▲] and [▼ DN], push [PWR] to turn power ON.
 - The internal CPU is reset.

■ CI-V remote control

•CI-V connection example

The transceiver can be connected through an optional CT-17 CI-V LEVEL CONVERTER to a personal computer equipped with an RS-232C port. The Icom Communications Interface-V (CI-V) controls the following functions of the transceiver.

Up to 4 Icom CI-V transceivers or receivers can be connected to a personal computer equipped with an RS-232C port. See p. 32 for setting the CI-V condition using set mode.

•Data format

The CI-V system can be operated using the following data formats. Data formats differ according to command numbers. A data area or sub command is added for some commands.

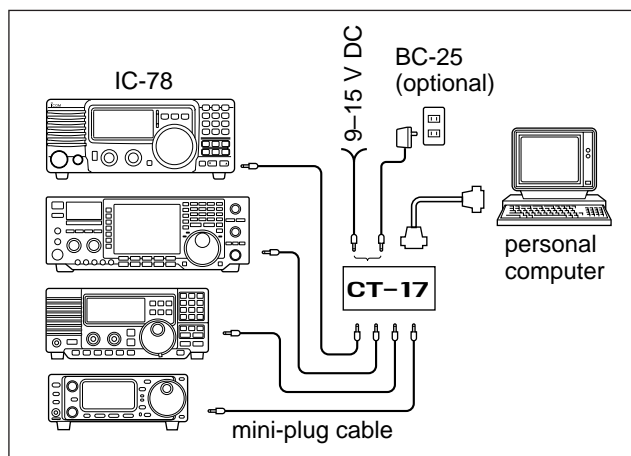

CONTROLLER TO IC-78

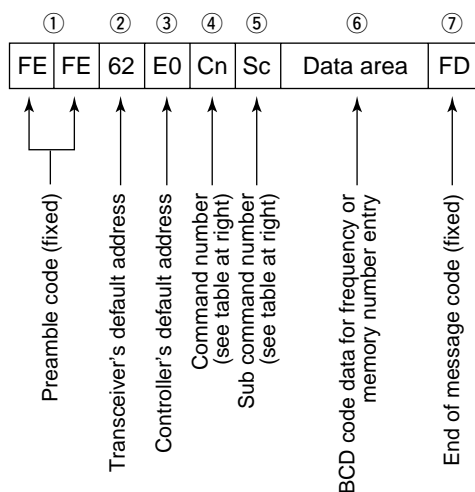

OK MESSAGE TO CONTROLLER

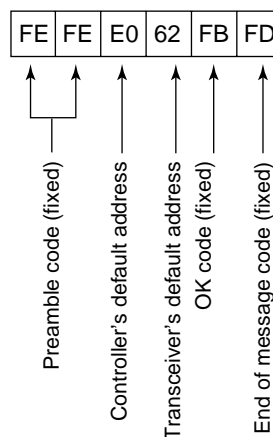

IC-78 TO CONTROLLER

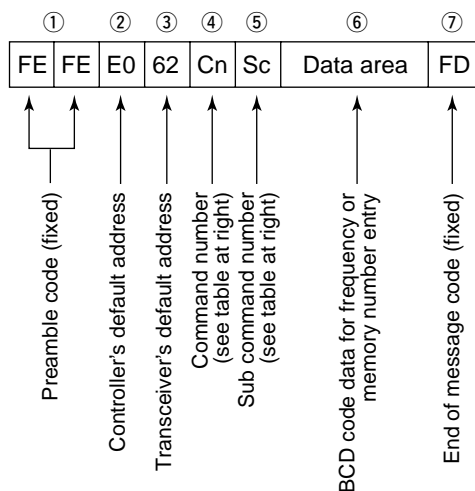

NG MESSAGE TO CONTROLLER

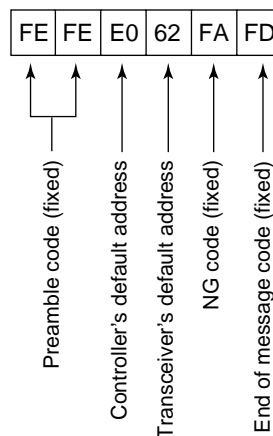

•Command table

Command	Sub command	Description
00	—	Send frequency data
01	—	Send mode data
02	—	Read Upper/Lower frequencies
03	—	Read frequencies
04	—	Read operating mode
05	—	Set operating frequency
06	—	Set mode
08	—	Set memory
	—	Set memory channel
0E	00	Scan stop
	01	Memory scan start
11	—	ATT
14	01	AF gain
	02	RF gain
	03	Squelch level
15	01	Read squelch Open/Close
	02	Read S-meter level
16	02	PREAMP
	22	Noise blanker
	44	Microphone compressor
19	00	Read ID

■ Data cloning between transceivers

•Data cloning

The IC-78's data (programmed frequencies, channel comment, both quick and initial set mode conditions, etc.) can be copied to the other IC-78. This function is useful when exactly the same setting of the IC-78s is required.

•Cloning operation

① Turn power OFF.

② Connects a mini-plug cable between two IC-78's (master and sub) [REMOTE] jack.

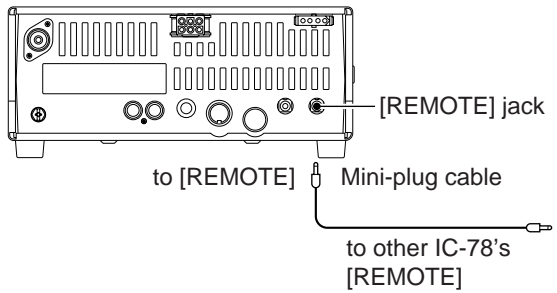

③ While pushing [TXF] and [FC], turn the master IC-78 power ON.

④ While pushing [SET] and [FC], turn the sub IC-78 power ON.

⑤ Push [TONE] of the master IC-78 to start cloning.

CL OUT M

Master transceiver indication

CL IN

Daughter transceiver indication

• After cloning complete;

CL END

Daughter transceiver indication

⑥ Turn power OFF

CLONE

M

Master transceiver indicates "M".

■ GENERAL

- Frequency range :
 - Rx 0.030000–29.999999 MHz*1
 - Tx 1.600000–29.999999 MHz*2
- *1Guaranteed range: 0.5–29.999999 MHz
- *2Not guaranteed for some frequency bands
- Mode : USB, LSB, CW, RTTY, AM
- No. of memory channels : 99 (Duplex) +1 call
- Frequency stability :
 - Less than ± 200 Hz from 1 min. to 60 min. after power ON. After that rate of stability less than ± 30 Hz/hr. at $+25^{\circ}\text{C}$ ($+77^{\circ}\text{F}$). Temperature fluctuations 0°C to $+50^{\circ}\text{C}$ ($+32^{\circ}\text{F}$ to $+122^{\circ}\text{F}$) less than ± 350 Hz
- Power supply requirement (negative ground)
 - 13.8 V DC $\pm 15\%$
- Current drain (at 13.8 V DC):

Receive	Stand-by	1.3 A
	max. audio	2.0 A
Transmit	max. power	20.0 A
- Operating temp. range: -10°C to $+60^{\circ}\text{C}$
; $+14^{\circ}\text{F}$ to $+140^{\circ}\text{F}$
- Antenna connector : SO-239 (50 Ω)
- Dimensions : 240(W) \times 95(H) \times 239(D) mm
(projections not included) 97/16(W) \times 33/4(H) \times 913/32(D) in
- Weight (approx.) : 3.8 kg; 8 lb 6 oz
- ACC connector : 13-pin

■ TRANSMITTER

- Modulation system :
 - SSB Balanced modulation
 - AM Low level modulation
- Output power :
 - SSB, CW, RTTY 2–100 W
 - AM 2–40 W
- Spurious emissions : Less than -46 dB below peak output power
- Carrier suppression : More than 40 dB
- Unwanted sideband : More than 50 dB
- Microphone connector: 8-pin connector (600 Ω)

■ RECEIVER

- Receiver system : Double-conversion superheterodyne
- Sensitivity (10 dB S/N) :
 - SSB, CW, RTTY 0.16 μV (1.600–29.999999 MHz)
(0.5 μV at 12 dB SINAD)
 - AM 13 μV (0.5–1.599999 MHz)
2 μV (1.600–29.999999 MHz)
- Selectivity :
 - SSB, CW, RTTY More than 2.1 kHz/ -6 dB
Less than 4.5 kHz/ -60 dB
 - AM More than 6.0 kHz/ -6 dB
Less than 20 kHz/ -40 dB
- Spurious and image rejection ratio:
(1.600–29.999999 MHz) More than 70 dB
- Audio output power : More than 2.0 W at 10% distortion with an 8 Ω load
(at 13.8 V DC)
- RIT variable range : ± 1200 Hz
- PHONES connector : 3-conductor 6.5 (d) mm ($1/4''$)
- Ext. SP connector : 2-conductor 3.5 (d) mm ($1/8''$)
/8 Ω

All stated specifications are typical and subject to change without notice or obligation.

11 OPTIONS

PS-85 DC POWER SUPPLY



Light weight switching regulator system power supply.

- Output voltage: 13.8 V DC
- Max. current drain: 20 A

AT-130/E AUTOMATIC ANTENNA TUNER



Matches the transceiver to a long wire antenna with a minimum of insertion loss.

AH-4 AUTOMATIC ANTENNA TUNER



Specially designed to tune a long wire antenna for portable or mobile HF operation. The PTT tuner start function provides simple operation.

- Input power rating: 120 W

AH-2b ANTENNA ELEMENT



A 2.5 m long antenna element for mobile operation with the AH-4.

- Frequency coverage: 3.5–28 MHz bands with the AH-4

MN-100 ANTENNA MATCHER



Match the transceiver to a dipole antenna. Covers all HF bands from 1.5 to 30 MHz. 8 m×2 antenna wires comes attached.

MN-100L ANTENNA MATCHER



Match the transceiver to a long wire antenna. Covers all HF bands from 1.5 to 30 MHz. 15 m×1 antenna wire comes attached.

AH-710 FOLDED DIPOLE ANTENNA

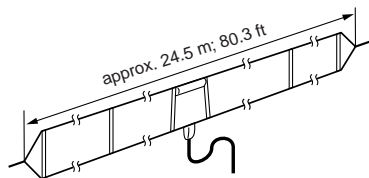

Covers from 1.9–30 MHz bands. Has an SO-239 connector. 30 m (98.4 ft) coaxial cable with PL-259 connector is supplied.

FL-52A, FL-53A, FL-96, FL-222 and FL-257 455 KHz FILTERS



- FL-52A: 500 Hz/-6dB (CW/RTTY narrow)
- FL-53A: 250 Hz/-6dB (CW narrow)
- FL-96: 2.8 KHz/-6dB (SSB wide)
- FL-222: 1.8 KHz/-6dB (SSB narrow)
- FL-257: 3.3 KHz/-6dB (SSB wide)

CR-338 HIGH-STABILITY CRYSTAL UNIT



Contains a temperature-compensating oven heater and crystal unit for improved frequency stability.

- Frequency stability: ±0.5 ppm

SP-7 EXTERNAL SPEAKER



Compact speaker for base station operation. Height can be adjusted for your convenience.

SP-20 EXTERNAL SPEAKER



4 audio filters; headphone jack; can connect to 2 transceivers.

- Input impedance: 8 Ω
- Max. input power: 5 W

SP-21 EXTERNAL SPEAKER



Designed for base station operation.

- Input impedance: 8 Ω
- Max. input power: 5 W

SM-6 DESKTOP MICROPHONE



Electret condenser-type desktop microphone.

SM-8 DESKTOP MICROPHONE



Including 2 connection cables for simultaneous connection of 2 transceivers. Has [UP]/[DOWN] switches.

SM-20 DESKTOP MICROPHONE



Unidirectional, electret microphone for base station operation. Includes [UP]/[DOWN] switches and a low cut function.

HM-36 HAND MICROPHONE



Hand microphone equipped with [UP]/[DOWN] switches. Same as supplied.

MB-23 CARRYING HANDLE



Carrying handle, convenient for portable operation.

IC-MB5 MOBILE MOUNTING BRACKET



Transceiver mounting bracket for mobile operation.

CT-17 CI-V LEVEL CONVERTER



For remote transceiver control using a personal computer. You can change frequencies, operating mode, memory channels, etc.

OPC-420 4-CONDUCTOR SHIELD CABLE
 For the connection between transceiver and antenna tuner. Compatible with the control cable, that is supplied with the AT-120, AT-130 and AH-4. Cable length: 10 m (32.8 ft)

OPC-599 ADAPTER CABLE
 13-pin, ACC connector to 7-pin + 8-pin ACC connector.

Count on us!